



McAlpine Product Catalogue

# Product Catalogue

McAlpine & Co Ltd  
Kelvin Avenue  
Hillington  
Glasgow G52 4LF

Tel: 0141 882 3213  
Fax: 0141 891 5065  
Fax: (Sales Office) 0141 883 5697

[www.mcalpineplumbing.com](http://www.mcalpineplumbing.com)



Complete Range of Plumbing Products

Complete Range of Plumbing Products





**NEW**

# **LATEST** Innovative Products

	Page
Wash Hand Basin Space Saver with Self-Closing Waste Valve	10
90mm x 25mm Water Seal Shower Trap	24
20mm Water Seal Shower Trap	26
110mm CP Plastic Flange	30
Internal/External Air Admittance Valve	88



# Contents

Latest Innovative Products .....	Inside Front Cover
Introduction.....	1
McAlpine Multifit.....	2

## Plastic Traps and Condensate Products

### SECTION 1

Anti-Syphon Traps (Silenttraps) .....	4
Resealing Bottle Traps.....	5
Bottle Traps.....	6-7
Chrome Plated Basin Traps, Pipe and Wall Flange.....	8
MacValve Self-Closing Waste Valve.....	9
Wash Hand Basin Space Saver with Self-Closing Waste Valve.....	10
Tubular Traps .....	10-11
Domestic Appliance Traps.....	12-13
Plumbing Kits for Sinks/Basin .....	14-15
Condensate Products .....	16-17
Bath Traps.....	18-19
Bath Fillers with Trap and Overflow .....	20
Overflow Manifold (Wasteflow), Chrome Plated Bath Trap with Overflow.....	21-22
110mm x 50mm Water Seal Pushfit Traps, Urinal Bowl Syphonic Traps and Condensation Trap ....	23
90mm Shower Traps with Top Access.....	24-25
1½" Shower Traps with Top Access .....	26-28
70mm Shower Trap and Shower Trap Accessories .....	29
Trap Washers, Bath and Shower Trap Accessories .....	30

## Shower and Floor Gullies, Channel Drain and Tile Drain

### SECTION 2

General Information .....	32
Assembly and Features of Trapped Gullies.....	33
Gullies for use with Sheet Flooring.....	34-35
Gullies for use with Tiled or Stone Floors where a Waterproofing Membrane is required.....	36-37
Two-Piece Gully and Gully with Non-Return Valve.....	38
Gullies with Non-Return Valve for use where floor depth is restricted.....	39-40
Gullies with Anti-Ligature Grating for use with Sheet Flooring.....	40
Top Access Shower Traps for use with Sheet Flooring, Tiled or Stone Floors .....	41
Tiles and Gratings.....	42
Gullies suitable for Concrete Ground Floors where a Waterproofing Membrane is not required....	43
Channel Drain for Tiled Floors .....	44-46
Tile Drain for Wet Floor Areas .....	47
Installation Guidelines.....	48-49
Conversion Kits.....	50
Accessories .....	51
Gully Flow Rates .....	52

## Plastic Waste Pipe and Fittings, Chrome Plated Brass Waste Pipe and Fittings, Drain Connectors, Mechanical Soil Pipe Boss Connectors, Aluminium Roof Flashing (MacFlash)

### SECTION 3

Multifit Waste Fittings .....	54-55
Flexible Waste Fittings and Non-Return Valves .....	56-57
Sundry Fittings .....	58
Surefit Waste System .....	59
Chrome Plated Brass Waste Pipe and Fittings .....	60-61
Drain Connectors and Blanking Off Caps .....	62
Mechanical Soil Pipe Boss Connectors .....	63
Aluminium Roof Flashing (MacFlash) .....	64

## Plastic Overflow Pipe and Fittings

### SECTION 4

3/4" Overflow Pipe, Pushfit and 19/23mm Universal Fittings .....	66
1 1/4" and 1 1/2" Overflow Pipe and Pushfit Fittings .....	67
Water Storage Cistern Fittings .....	68-69
Tundishes and Non-Return Valves .....	70
WC Overflow Kits with Tundish and Tee Pieces .....	71

## WC Connectors MACFIT, Flexible and Rigid

### SECTION 5

MACFIT WC Connectors .....	74-75
Flexible WC Connectors .....	76-77
Flexible WC Connectors for Back to Wall WC Pan .....	78
Rigid WC Connectors .....	79-81
WC Connector Accessories .....	81-82

## Air Admittance Valves (Ventapipe)

### SECTION 6

General Information .....	84-85
Ventapipe 100, 50, 25 and 15 .....	86-87
Ventapipe 100 Internal/External Air Admittance Valve .....	88-89
Installation Guidelines .....	90

## Waste Outlet Fittings, Waste Accessories and Handipak

### SECTION 7

General Information .....	92
Basin Waste Outlets .....	92-94
Bath Waste Outlets .....	95-97
Sink Waste Outlets .....	98-101
Shower Waste Outlets .....	102-104
Urinal Waste Outlets .....	105
Waste Accessories and Soap Dispenser .....	106
Handipak Carded Plumbing Range .....	107

## Technical Details and Index

### SECTION 8

Installation Guidelines .....	110
Table from BS EN 12056-2:2000 .....	111
Installation Information .....	112
Product Information .....	113
Product Code Index .....	114-118



## Introduction

M'Alpine commenced manufacturing plumbing products in 1902 and in 1957 was the first United Kingdom company to manufacture plastic traps and is still a privately owned family company.

M'Alpine now manufactures an exceptionally wide range of products of the highest quality for use in the United Kingdom and exports specifically designed products for use in over eighty countries worldwide.

As market leader, M'Alpine has a reputation for producing innovative products determined by market conditions and customer demand.

M'Alpine is a Member of the British Standards Institution, the British Plastics Federation and is an Associate Member of the Chartered Institute of Plumbing and Heating Engineers.

M'Alpine is actively involved in the promotion of quality products which are available in the United Kingdom from national and independent plumbers' and builders' merchants.



## Quality Control

M'Alpine operates strict quality control systems within all its factories, which are located in the West of Scotland, and is committed to the continued supply of high quality products.

## Technical Information

All information relating to plumbing regulations, installations and flow rates of traps, standards and patents has been included in the Technical Section (8) at the back of this catalogue.

**M'Alpine & Co. Ltd. owns intellectual property rights of the products described in this catalogue. These rights include, but are not limited to, patents, patent applications, registered designs, unregistered design rights, trademarks, unregistered trademarks and copyright.**

**Unless authorised by M'Alpine & Co. Ltd. the contents of this catalogue may not be copied in any way.**

**The company operates a policy of progressive improvements and reserves the right to alter the specification of any product without notice.**



# McAlpine Multifit

- Most McAlpine trap outlets and fittings have Multifit connections
- Multifit connections suit all plastic waste pipes to BS EN 1451-1:2000 and BS EN 1329-1:2000, copper pipe (metric or imperial) and lead pipe

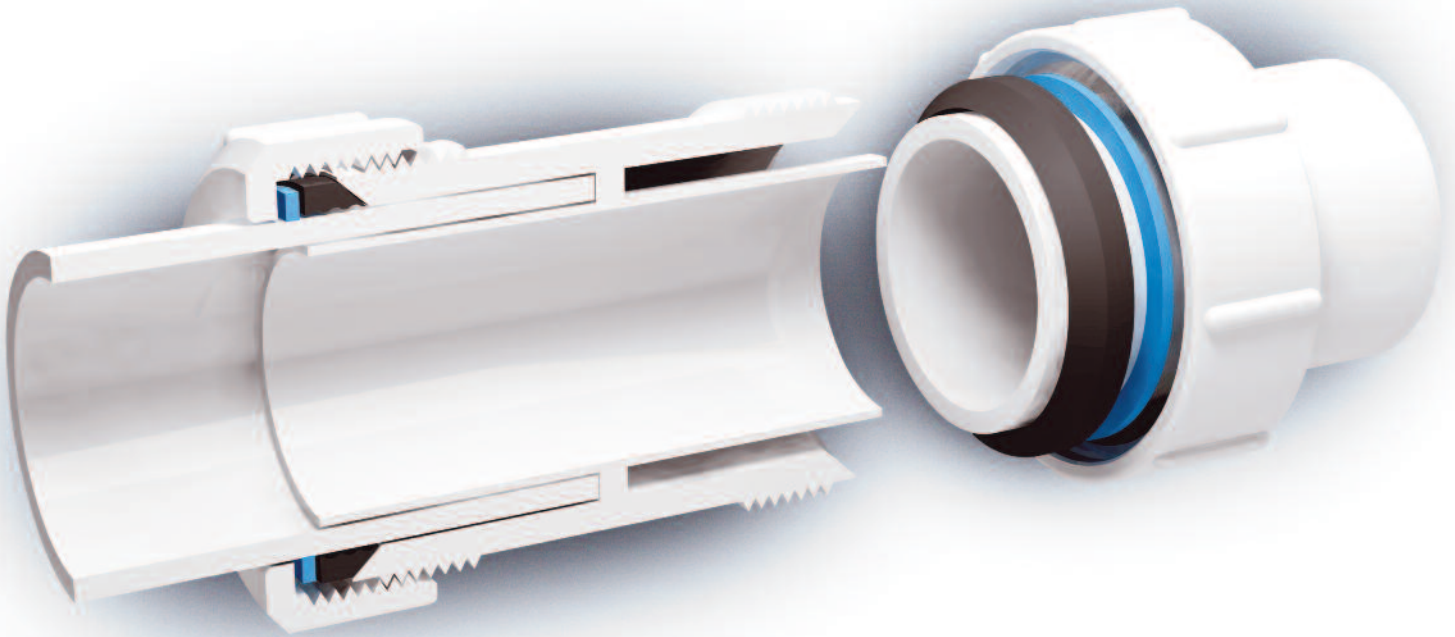

- The moulded internal sleeve of the connection, centres and supports the pipe. The Multifit and friction washers ensure a secure seal is made between the pipe and the wall of the fitting. When the compression nut is turned hand tight the best possible mechanical joint is complete
- If a plastic pipe is undersize, or out of shape, the end may require to be warmed to enable it to be pushed over the internal sleeve
- For technical reasons, it is not possible to manufacture Multifit connections on all traps and fittings. Where Multifit is not provided the description universal is applied. The only difference being that universal does not have an internal sleeve within the trap or fitting



# Plastic Traps Condensate Products

**M'ALPINE**  
Plumbing Products

SECTION

1



Plastic Traps and Condensate Products

# Anti-Syphon Traps (Silenttraps)

## General

- By drawing air through the valve, the Silenttrap neutralises syphonic pressure before it reaches the seal of the trap and therefore provides the equivalent of a ventilated system without the installation of costly and unsightly ventilation pipes
- The Silenttrap has been most rigorously tested and will not unseal, even under the most abnormal conditions
- The Silenttrap should continue to be effective irrespective of the distance between the appliance and the soil pipe

## Operation

Whenever syphonic conditions develop, the negative pressure causes the valve to rise, allowing air to be drawn into the discharge pipe. The pressure is thereby neutralised before it can have any effect on the water seal within the trap. On cessation of the syphonic action, the valve closes, making the Silenttrap air and watertight.

## Advantages

- The major advantage of the Silenttrap over Resealing Traps is that because the air is drawn through the valve and not through the water seal, gurgling is eliminated and a much quieter discharge is ensured
- Eliminates the need for secondary ventilation
- Silenttrap valves are available on a wide range of Bottle, Tubular and Bath Traps
- Silenttraps allow for greater flexibility in plumbing design



- The products below simply show that the Silenttrap attachment is available on Bottle, Tubular and Bath Traps. Popular Anti-Syphon Traps are shown throughout this catalogue. All traps marked\* are available as Anti-Syphon (Silenttrap). Add suffix 'V' to code



- A report of a special investigation by the Building Research Establishment on the performance of these traps under discharge and syphonic conditions is available on request



## General

Resealing Bottle Traps are an alternative to Anti-Syphon Traps (Silenttraps) and may be used in similar circumstances.

## Operation

When the trap is subject to syphonic conditions the automatic hydraulic action allows air to be drawn through the inlet of the trap and through the bypass columns thus breaking the syphonic action. On cessation of syphonic conditions the remaining water falls back to reseal the trap. The Silentrap ventilates by drawing air through a non-return valve, whereas the Resealing Trap ventilates by drawing air through the inlet of the trap and through the water seal.

## Advantages

- The simple non-mechanical action ensures retention of adequate water seal even under extreme syphonic conditions
- Eliminates the need for secondary ventilation

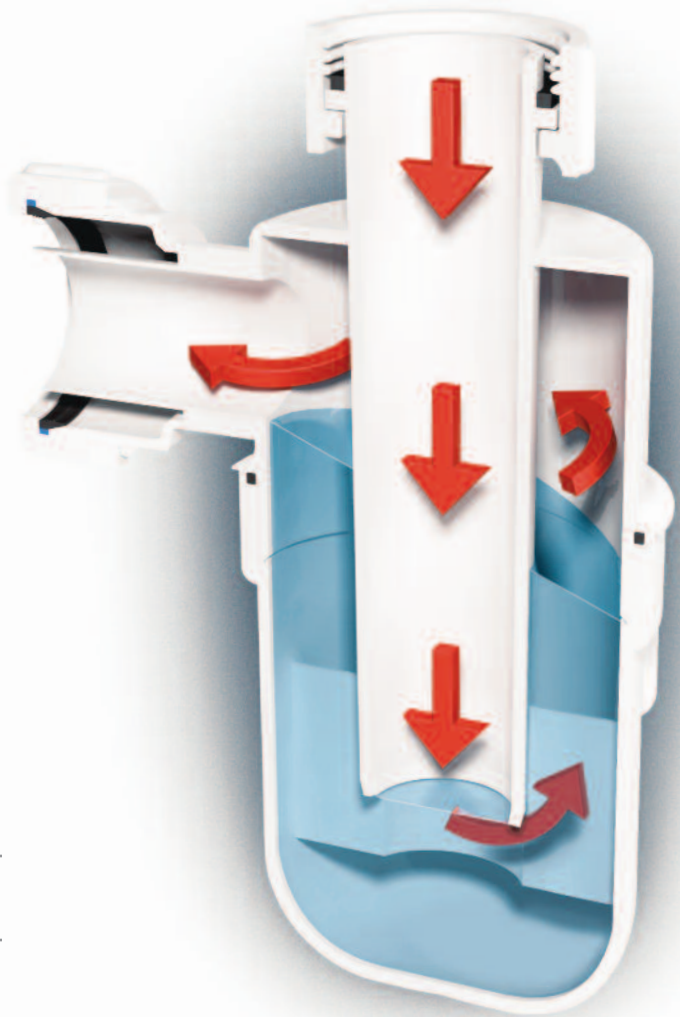

1¼" Code	1½" Code
<b>A10R</b>	<b>C10R</b>

### Standard



### Adjustable Inlet

<b>A10AR</b>	<b>C10AR</b>
--------------	--------------



### Adjustable Inlet Chrome Plated

<b>A10AR-CP</b>	<b>C10AR-CP</b>
-----------------	-----------------



### Resealing Shower Trap

Code	<b>STW4-RB</b>
------	----------------

- Full range of Resealing Shower Traps see pages 26-28

- Bends are available for converting 'P' traps to 'S' traps see page 6

# Bottle Traps with 75mm Water Seal

Bottle Traps with 75mm Water Seal



1¼" Code	1½" Code
-------------	-------------

**Standard**

<b>A10</b>	<b>C10</b>
------------	------------



1¼" Code	1½" Code
-------------	-------------

**Adjustable Inlet**

<b>AA10</b>	-
-------------	---



**Anti-Syphon (Silentrap)**

<b>A10V</b>	<b>C10V</b>
-------------	-------------



**Adjustable Inlet Basin Trap** with centre pin waste

<b>AA10W</b>	-
--------------	---



**Resealing**

<b>A10R</b>	<b>C10R</b>
-------------	-------------



**50mm Water Seal**

<b>E10</b>	-
------------	---



**Adjustable Inlet**

<b>A10A</b>	<b>C10A</b>
-------------	-------------



**38mm Water Seal**

-	<b>G10</b>
---	------------



**Anti-Syphon (Silentrap) Adjustable Inlet**

<b>A10AV</b>	<b>C10AV</b>
--------------	--------------



**Conversion Bend** to convert bottle 'P' trap to 'S' trap

<b>S1M</b>	<b>T1M</b>
------------	------------



**Resealing Adjustable Inlet**

<b>A10AR</b>	<b>C10AR</b>
--------------	--------------



### Chrome Plated Bottle Traps



1¼"	1½"
Code	Code

**Resealing Trap  
Adjustable Inlet**

A10AR-CP	C10AR-CP
----------	----------



**Adjustable Inlet**

CAA10	-
-------	---



### Anti-Syphon (Silentrap) incorporating a Silicone Valve

- The silicone valve prevents back pressure
- The Silentrap valve ensures retention of the water seal under extreme working conditions and eliminates the need for secondary ventilation
- The Silentrap valve reduces noise (gurgling) during discharge
- The silicone valve prevents foul odour or sewer gas entering the building if the water seal has evaporated which may occur due to lack of use through under occupancy
- Removable cup to facilitate easy cleaning
- Interchangeable with existing M<sup>C</sup>Alpine traps



1¼"	1½"
Code	Code

**Anti-Syphon (Silentrap)  
Adjustable Inlet with  
Non-Return Valve**

A10AV-SV	C10AV-SV
----------	----------



# Chrome Plated Basin Traps, Pipe and Wall Flange

- All kits except TA32UK-CB and TA32VUK-CB supplied with MS4-32SOLVENT fitting as illustrated. For additional fittings see pages 54 and 61
- For Chrome Plated Brass Waste Pipe and Fittings see pages 60 and 61

Chrome Plated Basin Traps, Pipe and Wall Flange

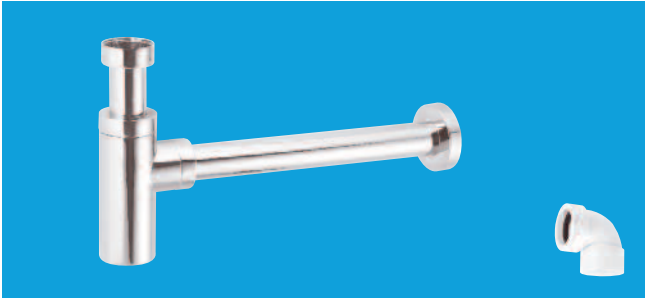

**1 1/4" x 50mm Water Seal Brass Adjustable Inlet Cylindrical Bottle Trap** with 12" length of 32mm OD CP brass waste pipe and wall flange

Code **CA32MINI-CB**

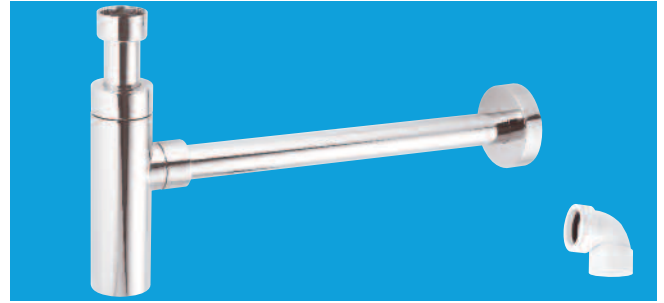

**1 1/4" x 75mm Water Seal Brass Adjustable Inlet Cylindrical Bottle Trap** with 16" length of 32mm OD CP brass waste pipe and wall flange

Code **CA32UK-CB**

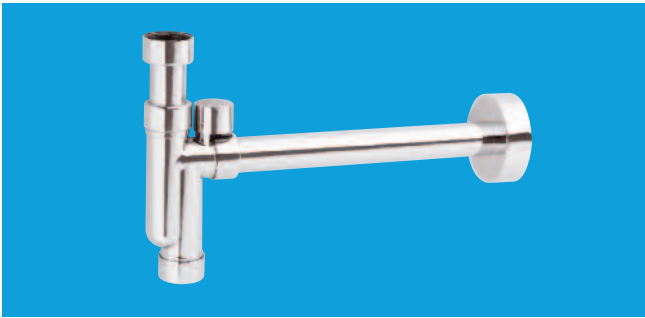

**1 1/4" x 50mm Water Seal Plastic Adjustable Inlet Tubular Anti-Syphon Trap (Silentrap)** with 12" length of 32mm OD CP brass waste pipe and wall flange

Code **TA32VUK-CB**

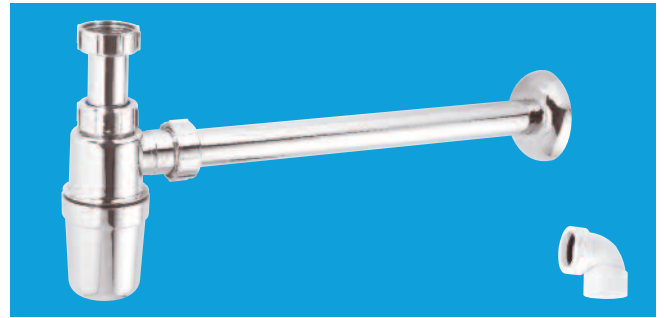

**1 1/4" x 75mm Water Seal Plastic Adjustable Inlet Bottle Trap** with 16" length of 32mm OD CP brass waste pipe and wall flange

Code **A32UK-CP**

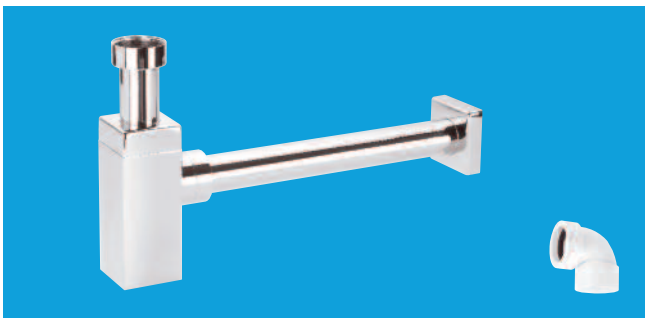

**1 1/4" x 50mm Water Seal Brass Adjustable Inlet Square Bottle Trap** with 12" length of 32mm OD CP brass waste pipe and wall flange

Code **CA32SQUK-CB**

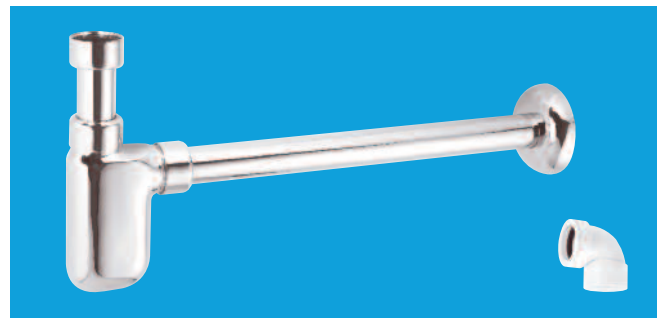

**1 1/4" x 75mm Water Seal Brass Adjustable Inlet Bottle Trap** with 16" length of 32mm OD CP brass waste pipe and wall flange

Code **A32UK-CB**

# MacValve Self-Closing Waste Valve

Patent Pending

## SECTION 1

- Can be fitted in horizontal or vertical position
- MacValve membrane opens under water pressure to allow discharge to flow freely and then closes to form a seal to prevent foul odour or sewer gas entering the building
- MacValve can be fitted in installations where a non-return valve can be of benefit to the plumbing installation
- MacValve can be used to take the discharge from a pressure relief valve on an unvented domestic hot water storage system. Please refer to guidance notes in approved Document G3 of the Building Regulations

- MacValve having no water seal can never dry out through evaporation or lack of use of an appliance as the membrane remains sealed
- MacValve must not be used for baths or shower trays unless there is access for maintenance



**MacValve** 1 1/4" BSP female inlet nut x 1 1/4" universal compression outlet

Code **MACVALVE-1**

**MacValve** 1 1/2" BSP female inlet nut x 1 1/2" universal compression outlet

Code **MACVALVE-2**



**MacValve** 2" universal compression outlet x 2" universal compression outlet

Code **MACVALVE-4**



The **Tundish** adaptor can be cut to give a 22mm plain tail

**MacValve** 1 1/4" BSP female inlet nut x 1 1/4" universal compression outlet including Tundish adaptor 1 1/4" BSP male thread x 22mm universal inlet

Code **MACVALVE-3**

*When installed horizontally the flow arrow must be in the uppermost position*



**90° Bend** 1 1/4" female inlet nut x 1 1/4" BSP male connector

Code

**S4U\***

**90° Bend** 1 1/2" female inlet nut x 1 1/2" BSP male connector

**T4U\***



**Straight Connector** 1 1/4" BSP male thread x 1 1/4" universal compression connection

**S31U\***

**Straight Connector** 1 1/2" BSP male thread x 1 1/2" universal compression connection

**T31U\***

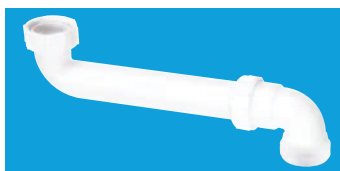

**1 1/2" Space Saver MacValve Inlet**

**SSINLET1**

**1 1/4" Space Saver MacValve Inlet**

**SSINLET2**

**\* S4U, T4U, S31U AND T31U FITTINGS ONLY SUITABLE FOR USE WITH MACVALVE**

**Do not pour drain cleaner down these products**



## Wash Hand Basin Space Saver with Self-Closing Waste Valve

- Designed to allow full use of storage space below the basin within the cabinet or furniture
- The internal membrane opens under water pressure to allow discharge to flow freely and then closes to form a seal to prevent foul odour or sewer gas entering the building
- The valve allows air to be drawn into the discharge waste pipe when negative pressures occur and eliminates the need for secondary ventilation to the discharge pipework. This allows for greater flexibility in the plumbing design
- The valve can be easily cleaned without having to disassemble the discharge pipework. Simply remove the split pin at the front of the valve, take out the plug and membrane and clean in hot soapy water. Reassemble and relocate the split pin in the slot provided
- The WHB self-cleaning waste valve having no water seal can never dry out through evaporation or lack of use of the basin as the membrane seal remains closed
- Overall height 62mm
- Do not pour drain cleaner down this product



1 1/4" BSP female inlet nut x 1 1/4" universal compression outlet

Code

**WHB-1**

## Tubular Traps with 75mm Water Seal



1 1/4" Code	1 1/2" Code	2" Code
SA10	SC10	SE10

Swivel 'P'

SA10 SC10 SE10



1 1/4" Code	1 1/2" Code	2" Code
ASA10	ASC10	ASE10

Adjustable Inlet

ASA10 ASC10 ASE10



Anti-Syphon (Silentrap)

SA10V SC10V SE10V



Adjustable Inlet  
Anti-Syphon (Silentrap)

ASA10V ASC10V ASE10V

# Tubular Traps with 75mm Water Seal

## SECTION 1



1¼" Code	1½" Code	2" Code
<b>Adjustable Inlet Basin Trap</b> with centre pin waste		
<b>ASA10W*</b>	-	-



1¼" Code	1½" Code	2" Code
<b>Low Inlet</b>		
<b>BT3*</b>	-	-



1¼" Code	1½" Code	2" Code
<b>50mm Water Seal</b>		
<b>BT4</b>	-	-



1¼" Code	1½" Code	2" Code
<b>Adjustable Inlet</b> with connection for 19/23mm pipe		
<b>ASA10-SP* ASC10-SP*</b>	-	-



1¼" Code	1½" Code	2" Code
<b>Swivel 'S'</b>		
<b>SB10</b>	<b>SD10</b>	<b>SF10</b>



1¼" Code	1½" Code	2" Code
<b>All One</b>		
<b>SP10</b>	<b>TP10</b>	<b>ZP10</b>



1¼" Code	1½" Code	2" Code
<b>All One Anti-Syphon (Silentrap)</b>		
<b>SP10V</b>	<b>TP10V</b>	-



1¼" Code	1½" Code	2" Code
<b>Running 'P'</b>		
<b>SR10*</b>	<b>TR10*</b>	<b>SG10*</b>



1¼" Code	1½" Code	2" Code
<b>Running 'S'</b>		
<b>SS10</b>	<b>TS10</b>	<b>SH10</b>



1¼" Code	1½" Code	2" Code
<b>Running</b> suitable for most waste disposal units		
-	<b>TT10*</b>	-



1¼" Code	1½" Code	2" Code
<b>Running</b> with 20mm water seal		
-	<b>TRSH10</b>	-



1¼" Code	1½" Code	2" Code
<b>Adjustable Inlet</b> with 19mm water seal		
<b>BT1</b>	<b>BT2</b>	-



1¼" Code	1½" Code	2" Code
<b>Offset Basin Trap</b> with adjustable inlet and cleaning eye		
	<b>OBT1</b>	



1¼" Code	1½" Code	2" Code
<b>Offset Anti-Syphon (Silentrap) Basin Trap</b> with adjustable inlet and removable anti-syphon valve for cleaning purposes		
	<b>OBT1V</b>	



1¼" Code	1½" Code	2" Code
<b>Straight Through</b> with one cleaning eye		
1¼" Inlet x 1¼" outlet <b>X10</b>		



1¼" Code	1½" Code	2" Code
<b>Straight Through Anti-Syphon (Silentrap)</b> with one cleaning eye		
1¼" Inlet x 1¼" outlet <b>X10V</b>		



1¼" Code	1½" Code	2" Code
<b>Straight Through</b> with two cleaning eyes		
1¼" Inlet x 1¼" outlet <b>X10A</b>		
1¼" Inlet x 1½" outlet <b>Y10</b>		

# Domestic Appliance Traps 1½" x 75mm Water Seal

## General

- Domestic Appliance Traps provide the facility to accept the discharge from a washing and/or dishwashing machine(s) and are suitable for new and existing installations
- In all cases a blank cap, plug or blank nozzle is provided with the trap. Should the domestic appliance not be connected at the time of installation, the trap will function as a normal sink trap whilst providing an easily accessible point for the future installation of any appliance(s)

## Sink Traps with connection for the discharge from domestic appliance(s)



Code **WM1\***



Code **WM2**



Code **WM2V**



Code **WM14\***

## With Adjustable Inlet



Code **WM11\***



Code **WM12\***



Code **WM15\***



Code **ASC10-CO\***

## Standpipe Trap and Fittings



**Twin Connector** for plumbing two domestic appliance discharge hoses into standpipe trap

Code **V33WM**

- Multifit outlet to suit either 1½" or 40mm diameter standpipe
- 135° swivel nozzles for washing and/or dishwashing machine discharge hoses - supplied with blanking plugs
- Discharge hose(s) to be taken to the height stated by the appliance manufacturer(s)
- An air break, as specified by appliance manufacturers is incorporated within the connector



**Standpipe Cap** with retaining clip

Code **WM3-CAP**



**Standpipe Trap**

Code **WM3\***

All traps marked\* available as anti-syphon (Silentrap). Add suffix 'V' to code. See page 4 for technical details



## Sink Trap with TeeVent

- The TeeVent system, which incorporates a non-return valve, provides an air break and enables the waste system to be sealed. This system has the advantage over a standpipe arrangement in that should a blockage occur, the non-return valve prevents flooding
- TV1 can be used with domestic appliance trap WM4
- All domestic appliance traps must be fitted in accordance with the fixing instruction leaflet included with each trap

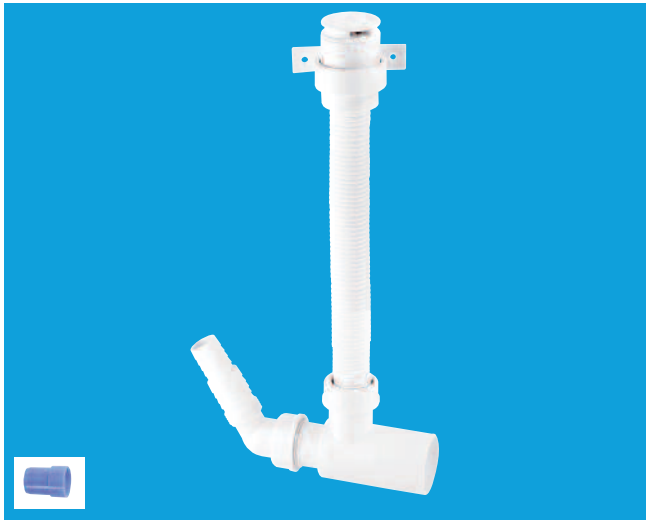

Code **TV1**



Code **WM4\***

## Accessories



**Straight Nozzle** for connection to 1½" Multifit

Code **WMF3**



**90° Nozzle** for connection to 1½" Multifit

Code **WMF4**



**135° Nozzle** for connection to 1" BSP thread

Code **MA15**



**Blanking Plug** for traps and fittings

Code **228532**



**Swept Tee** BSP nut x BSP thread x nozzle for discharge hose of domestic appliance

1½" x 1½" x ¾"

Code **V33L**

1¼" x 1¼" x ¾"

Code **V34L**



**Tee Piece** BSP nut x BSP thread x 135° nozzle for discharge hose of domestic appliance

1½" x 1½" x ¾"

Code **V33S**

- When installing domestic appliance traps, care should be taken to observe the instructions of the manufacturer of the appliance, particularly with regard to the height of the discharge hose and the incorporation of an air break or vent to atmosphere

# Space Saver and Standard Plumbing Kits for Sinks. Plumbing

## General

- Space Saver Kits are designed to allow full use of storage space below the sink bowl(s) and are suitable for use with almost all British and European sinks
- All kits have 1½" inlet connections and the provision for the discharge hose(s) of domestic appliance(s). Also supplied with a 1½" x 75mm water seal tubular swivel 'P' trap
- Each kit is boxed individually and supplied with an illustrative drawing

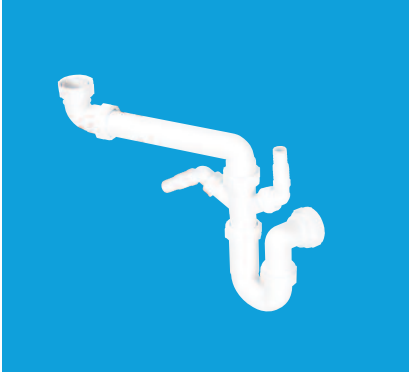

Single Bowl Kit

Code

**SSK1**

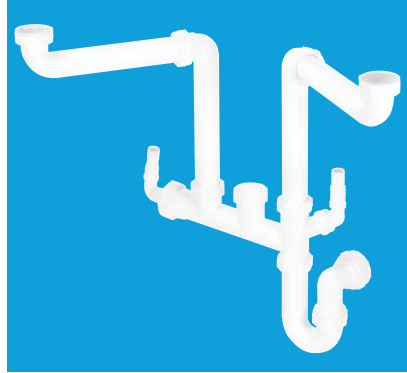

Double Bowl Kit

Code

**SSK2**

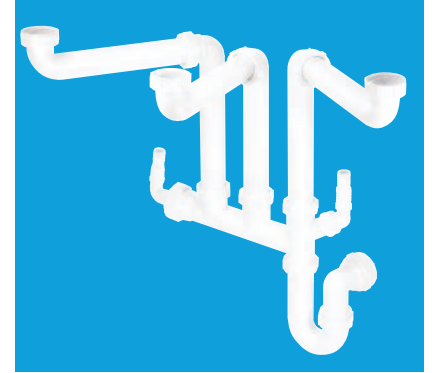

Three Bowl Kit

Code

**SSK3**

## Space Saver Plumbing Kits

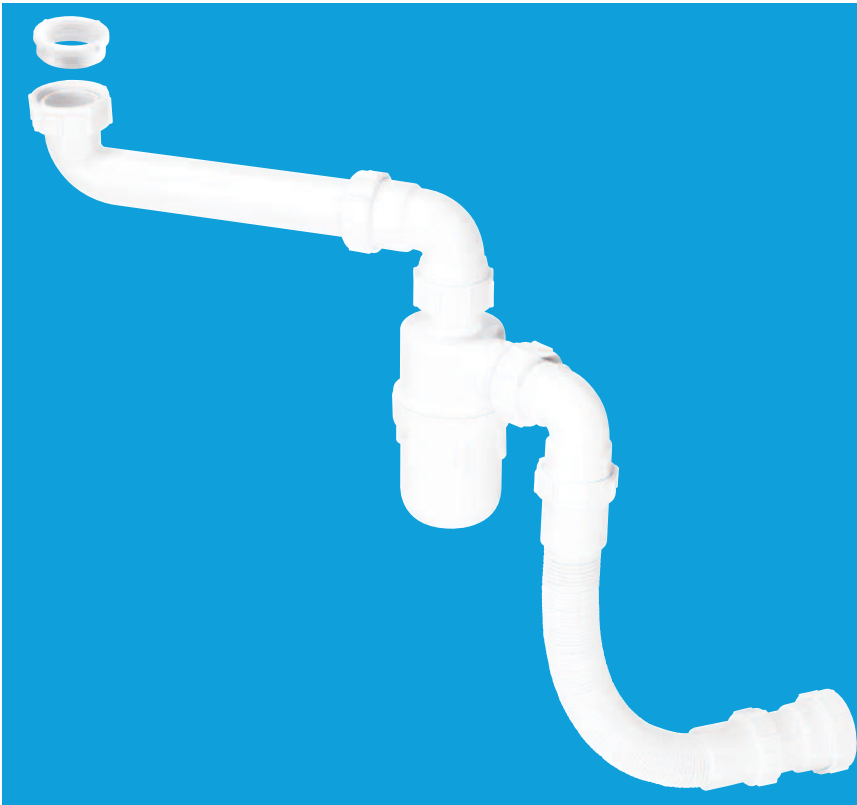

1¼"/1½" Plumbing Kit for adjustable height basin or sink  
(supplied with T16 1½"/1¼" trap inlet reducer)

Code

**FLEXPIT1**

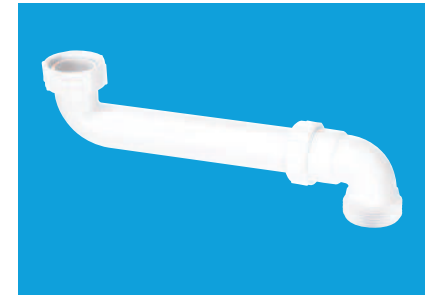

1½" Space Saver Trap Inlet

Code

**SSINLET1**

1¼" Space Saver Trap Inlet

Code

**SSINLET2**

### General

- Standard Kits have the provision for the discharge hose(s) of domestic appliance(s) and are suitable for use with almost all British and European sinks
- All kits have 1½" inlet connections and the provision for the discharge hose(s) of domestic appliance(s). Also supplied with a 1½" x 75mm water seal tubular swivel 'P' trap
- Each kit is supplied in a polythene bag complete with an illustrative drawing

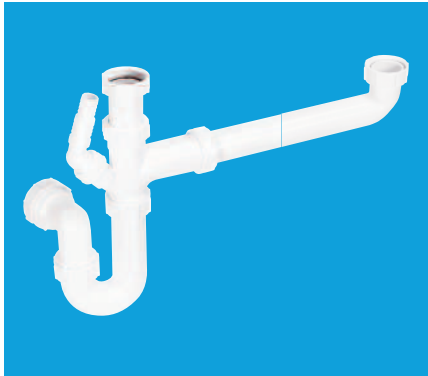

**Bowl and a Half Kit**

Code **SK1**

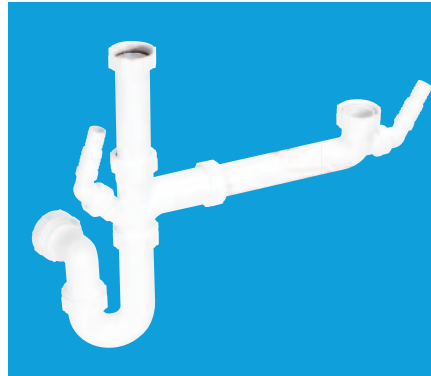

**Bowl and a Half Kit**

Code **SK1A**

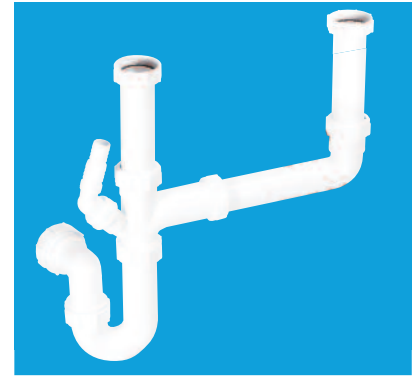

**Double Bowl Kit**

Code **SK2**



**Double Bowl Kit**

Code **SK2A**

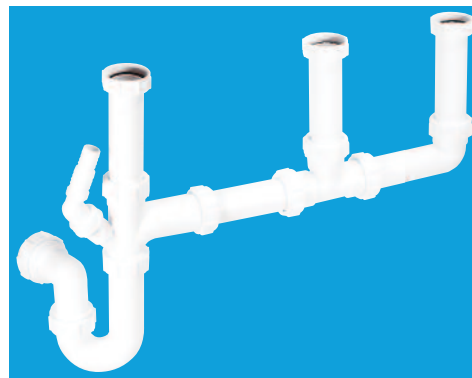

**Three Bowl Kit**

Code **SK3**



**Blanking Plug(s)**  
included with all  
plumbing kits

Code **228532**



Code **SK1**



# Condensate Products for Connecting Condensate Discharge

## Basin and Sink Traps



**1 1/4" x 75mm Water Seal Tubular Swivel Basin Trap** with adjustable inlet and connection for 19/23mm pipe. Supplied with blanking cap

Code **ASA10-SP\***



**1 1/2" x 75mm Water Seal Tubular Swivel Sink Trap** with adjustable inlet and connection for 19/23mm pipe. Supplied with blanking cap

Code **ASC10-SP\***



**1 1/2" x 75mm Water Seal Tubular Swivel Sink Trap** with adjustable inlet, nozzle for discharge hose of domestic appliance and connection for 19/23mm pipe. Supplied with blanking cap

Code **ASC10-CO\***



**19/23mm Inlet and Outlet x 75mm Water Seal Offset Trap** to receive discharge from a condensing boiler. Supplied with support clip

Code **OBT1-CO**

## Flexible Connector from Condensing Boiler to Rigid or Flexible Condensate Discharge Pipe

- Easy connection to boiler condensate discharge pipe
- Allows for disconnection in freezing conditions for discharge to be redirected into a receptacle
- Universal compression connections suitable for 19/23mm rigid pipe and 25mm flexible pipe



**200mm Flexible Connector**

Code **CONFLEX-200**

**300mm Flexible Connector**

Code **CONFLEX-300**

## Flexible Condensate Pipe Kit

- For use in installation of condensing boilers
- Eliminates use of traditional rigid discharge pipe and fittings thereby allowing complete flexibility to discharge point
- Includes fittings to allow for easy connection to sanitary pipework
- Allows for disconnection in freezing conditions for discharge to be redirected into a receptacle
- Particularly useful where installation space is restricted



Flexible Condensate Pipe Kit - contents

- 1 x 3m length of 25mm flexible pipe
- 6 x 25mm pipe clips
- 2 x straight connectors with universal compression connections suitable for 19/23mm rigid pipe and 25mm flexible pipe
- 1 x 1 1/2" plain tail ABS solvent weld reducer to 19/23mm rigid pipe and 25mm flexible pipe

Code

**CONFLEX-KIT1**

### Soakaway - Container for use with limestone chippings. External use only



**110mm x 300mm x 1¼" / 1½"**  
**Pipe top and side Inlet Connections** to receive discharge from a condensing boiler. 19/23mm x 1¼" fitting provided to increase size of discharge pipe before it passes through the external wall

---

Code **SOAK1GR**

### Auxiliary Fittings



**Pipe Clamp to suit 1¼"/1½"**  
**Pipe** to BS EN 1451-1:2000/BS EN 1329-1:2000 with universal compression connection for 19/23mm rigid pipe

---

Code (Grey) **CLAMP1GR**  
 Code (White) **CLAMP1WH**



**1½" x 1½" x 19/23mm Universal Slip Tee** with universal compression connections for 19/23mm rigid pipe

---

Code **V1MX-CO**



**In-line Vertical Non-Return Valve** with inlet and outlet connection for 19/23mm pipe

---

Code **CONVALVE**



**Straight Connector** with universal compression connections for 19/23mm rigid pipe and 25mm flexible pipe

---

Code **R1M-CO**



**50mm Tundish** with 19/23mm pipe outlet

---

Code **TUN-2**

### Mechanical Soil Pipe Boss Connectors



**Mechanical Soil Pipe Boss Connector 57mm hole saw size.** Supplied with fixing tool

---

4"/110mm x 1¼" pipe  
 Code **BOSSCONN110-BL**

---

4"/110mm x 1½" pipe  
 Code **BOSSCONN110T-BL**

---

4"/110mm x 1¼" pipe  
 Code **BOSSCONN110-GR**

---

4"/110mm x 1½" pipe  
 Code **BOSSCONN110T-GR**



**Two-Piece Cast Iron Soil Pipe Boss Connector to suit 22mm drill size.** Supplied with fixing tool

---

4"/100mm x 1¼" pipe  
 Code **BOSS110CAST-BL**

---

4"/100mm x 1½" pipe  
 Code **BOSS110TCAST-BL**

---

3½"/90mm x 1¼" pipe  
 Code **BOSS90CAST-BL**

---

3½"/90mm x 1½" pipe  
 Code **BOSS90TCAST-BL**

---

3"/82mm x 1¼" pipe  
 Code **BOSS82CAST-BL**

---

3"/82mm x 1½" pipe  
 Code **BOSS82TCAST-BL**



**Mechanical Soil and Rainwater Pipe Boss Connector** for 1¼" pipe

---

Code **BOSSCONN1.25BL**  
 Code **BOSSCONN1.25GR**



**Reducer in ABS 1¼" plain tail** x 19/23mm universal compression connection

---

Code **R16-BL**  
 Code **R16-GR**



**Mechanical Soil and Rainwater Pipe Boss Connector** for 19/23mm pipe

---

Code **BOSSCONN-22MM**

For full range of Boss Connectors see page 63

# Bath Traps 75mm, 60mm, 50mm and 19mm Water Seal

## Bath Traps without Overflows



1 1/2" x 75mm Water Seal

Code **L10**



1 1/2" x 75mm Water Seal Anti-Syphon (Silentrap)

Code **L10V**



1 1/2" x 60mm Water Seal (Extended Body)

Code **SM10E**

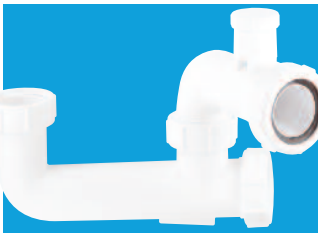

1 1/2" x 60mm Water Seal (Extended Body) Anti-Syphon (Silentrap)

Code **SM10EV**



1 1/2" x 50mm Water Seal

Code **SM10**



1 1/2" x 50mm Water Seal Anti-Syphon (Silentrap)

Code **SM10V**

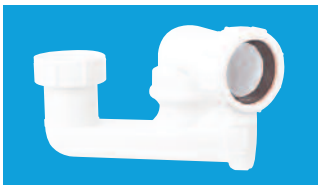

1 1/2" x 50mm Water Seal

Code **SMP10**



1 1/2" x 50mm Water Seal Anti-Syphon (Silentrap)

Code **SMP10V**

■ For Bath Waste Outlet Fittings suitable for use with the above Traps see pages 93-95



1 1/4" x 19mm Water Seal

Code **P10**

1 1/2" x 19mm Water Seal

Code **Q10**

## Bath Trap with Top Access

- 1 1/2" x 50mm water seal swivel bath trap
- CP brass waste with top access and spring-loaded mushroom plug
- Matching CP mushroom plug and CP overflow face
- Adjustable flexible overflow tube length 330mm - 580mm
- Overall height of trap only 112mm
- **FOR EXTENSION KIT SEE PAGE 30**



Code

**HC2650UK**

## Bath Traps with Overflows



**1½" x 75mm Water Seal** with flexible overflow tube and CP overflow grating

Code

FJ10\*



**1½" x 75mm Water Seal** with flexible overflow tube and CP overflow grating and 70mm flange centre pin waste outlet fitting

Code

FJ10WC\*



**1½" x 60mm Water Seal (Extended Body)** with flexible overflow tube and CP overflow grating

Code

FSK10E\*



**1½" x 50mm Water Seal** with flexible overflow tube and CP overflow grating

Code

FSK10\*

■ For Bath Waste Outlet Fittings suitable for use with the above traps see page 95

All traps marked\* available as anti-syphon (Silentrap). Add suffix 'V' to code. See page 4 for technical details



# Bath Fillers with Trap and Overflow

## General

- Filler manufactured in cast brass
- Compact filler design 70mm diameter x 25mm deep suitable for curved baths
- Will fit overflow hole size 46mm to 65mm
- 0.5 bar pressure produces 33 litres per minute  
1.0 bar pressure produces 44 litres per minute  
2.0 bar pressure produces 57 litres per minute
- **650mm WRAS approved braided hose with 90° bend**
- All traps 1½" x 50mm water seal with Multifit outlet
- Compression overflow connection to trap
- **HC2650UK-FIL** has a standard overflow length of 575mm but is available with a 1m length. Incorporates a swivel bath trap and CP brass waste with top access spring-loaded mushroom plug. Overall height 112mm
- **HCN3365UK** has a standard overflow length of 575mm but is available with a 1m length. Incorporates a CP brass waste and spring-loaded mushroom plug
- **HCN3165UK** has a standard cable and overflow length of 575mm but is available with a 1m cable and overflow. Incorporates CP brass waste and mushroom pop-up plug

Bath Fillers with Trap and Overflow



Code **HCN3365UK**  
Code **HCN3365UK-1M**

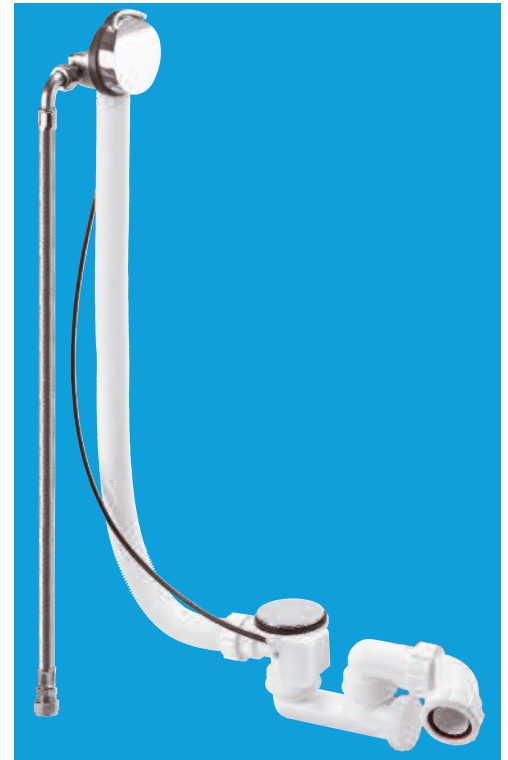

Code **HCN3165UK**  
Code **HCN3165UK-1M**

■ **FOR EXTENSION KIT SEE PAGE 30**



Code **HC2650UK-FIL**  
Code **HC2650UK-FIL-1M**



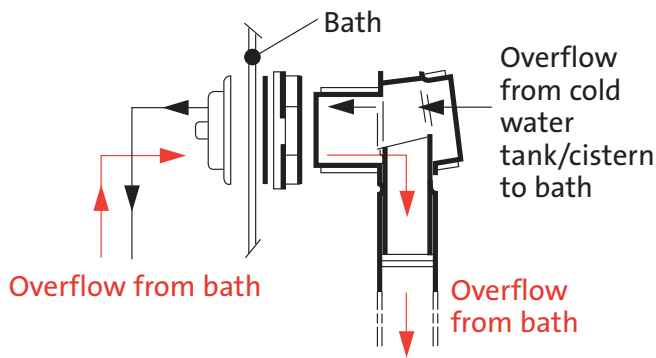

### General

- Bath Wasteflow units enable the overflow and/or warning pipe from a cold water storage cistern and a WC flushing cistern (not fitted with an integral overflow) to be installed so that the discharge is directed into the bath via the bath overflow grating
- The construction of the Wasteflow is such that whilst acting as a conventional overflow for the bath, any overflow from a connected cistern is discharged through the overflow grating into the bath thereby providing a visible warning
- A feature of the Wasteflow design ensures that should the overflow grating be blocked, the overflow from the cistern is diverted to discharge directly into the bath trap and not

back along the overflow pipe thereby reducing the risk of flooding

- Wasteflow is also available with connection for condensate

### Advantages

- Wasteflow is available in various forms that allow greater flexibility for the discharge of cistern overflows and condensate
- No unsightly external overflow pipes
- No damage to outside walls
- No risk of freezing
- No risk to other tenants or public

### Installation

- Wasteflow is supplied with a choice of 50mm, 60mm or 75mm water seal trap
- Wasteflow is installed under the roll of the bath
- Wasteflow fittings shown on page 20 enable a range of connections that may be housed within the roll of the bath or if necessary extended into a duct space
- Overflow pipes connected to Wasteflow should have an adequate and continuous fall to ensure a natural gravity discharge



**Wasteflow** with pop-up waste and trap, CP brass control knob, CP stainless steel waste flange and plug

With L10 Trap **PUWF3-CP\***

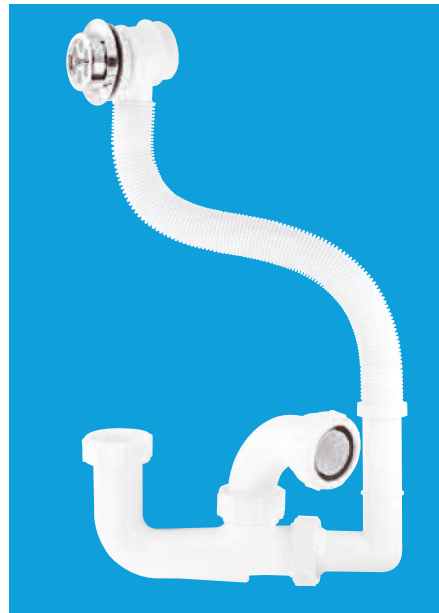

**Wasteflow** with trap

With FJ10 Trap **FJWF1\***

- Bath Waste Outlet Fittings see page 95

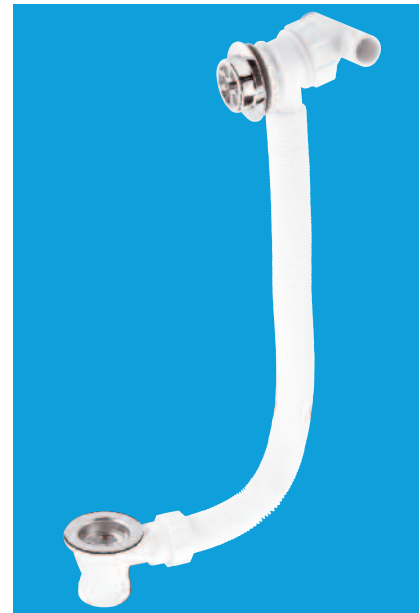

**Wasteflow** with 1½" waste outlet fitting, plug, chain and two way connector

Code **WF21**

- Wasteflow Manifolds have a 1½" BSP male thread on the inlet and will normally require an additional fitting from the list on page 22

All traps marked\* available as anti-syphon (Silentrap). Add suffix 'V' to code. See page 4 for technical details

## Overflow Manifold (Wasteflow) Chrome Plated Bath Trap with Overflow

### Wasteflow



**Wasteflow** can be fitted with R11, R12 or R15 connector (order as required) for connection to overflow warning pipe. Side inlet connection for 19/23mm condensate or condense drain

Code **WF21-SP**

### Wasteflow Fittings



**Straight Connector** 1½" loose nut x connection for 19/23mm pipe

Code **R11**



**Four Way Connector** 1½" loose nut x four connections for 19mm pipe, supplied with three plugs

Code **R12**

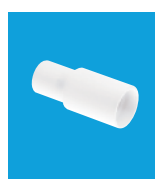

**ABS Adaptor** to convert 19mm connections on R12 and R15 fittings up to 23mm OD pipe

Code **R13**



**¾" In-Line Non-Return Valve**

Code **R14**



**2 Way Connector** 1½" loose nut x two connections for 19mm pipe, supplied with one plug

Code **R15**

■ See page 71 for WC Overflow Kits with Tundish

### Chrome Plated Brass Bath Traps with Combined Waste and Overflow



Trap only

**1½" x 50mm Water Seal CP Brass Trap:** 1½" CP brass combined waste and overflow with 70mm spring-loaded mushroom plug and matching overflow face

Code **BRASSTRAP-50-CP**

**1½" x 25mm Water Seal CP Brass Trap:** 1½" CP brass combined waste and overflow with 70mm spring-loaded mushroom plug and matching overflow face

Code **BRASSTRAP-25-CP**

**Trap only**

**1½" x 50mm Water Seal CP Brass Trap** x 1½" universal compression outlet

Code **BATHTRAP50-CPB**

**1½" x 25mm Water Seal CP Brass Trap** x 1½" universal compression outlet

Code **BATHTRAP25-CPB**

# 110mm x 50mm Water Seal Pushfit Traps, Urinal Bowl Syphonic Traps and Condensation Trap

## 110mm x 50mm Water Seal Pushfit Traps

**Pushfit Traps** are manufactured in high density polyethylene and the inlet and outlet sealing rings from a proven synthetic rubber compound. Pushfit traps will suit WC squatting pans, slop hoppers or similar appliances with 90-114mm plain end outlet and will connect to 110mm pipe



Code **WCTRAP4P**



Code **WCTRAP4S**

## Urinal Bowl Syphonic Traps

**Syphonic Traps** have inlets to suit continental style syphonic urinal bowl to create a 75mm water seal trap. Outlet to suit 2" BS EN 1329-1:2000 solvent weld pipe



**Syphonic 'P' Trap**

Code **HCUP50UK**



**Syphonic 'S' Trap**

Code **HCUS50UK**

## Condensation Trap

**Condensation Trap** has been designed as a straight socket connector for 110mm and 125mm pipe (commonly used as ducting for basic air extraction systems) and provides an internal trap/diverter which will collect condensation forming on the internal surface of the extract pipework. It allows for the connection of a 19/23mm pipe, which can be installed to drain off the condensation to a convenient position



110mm pipe

Code **CONTRAP1**

125mm pipe

Code **CONTRAP2**



# 90mm Shower Traps with 50mm Water Seal

90mm Shower Traps with 50mm Water Seal and removable 110mm Flange to

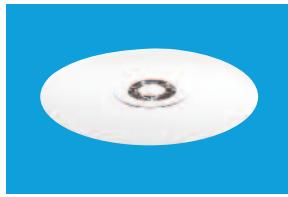

CP Plastic Flange

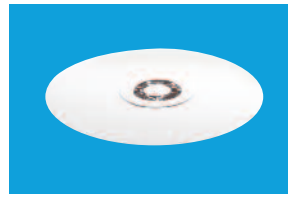

CP Brass Flange



CP Brass Flange

90mm Shower Traps with 50mm Water Seal



24

**90mm x 25mm Water Seal with 1½" Solvent Weld Outlet Socket**  
Overall height 53mm

ST90CP10-53

ST90CB10-53

ST90CPB-P-53



34

**90mm x 50mm Water Seal with 1½" Universal Compression Outlet**  
Overall height 70mm

ST90CP10-70

ST90CB10-70

ST90CPB-P-70



42

**90mm x 50mm Water Seal with 1½" Universal Compression Outlet**  
Overall height 90mm

ST90CP10-HP2

ST90CB10-HP2

ST90CPB-P-HP2

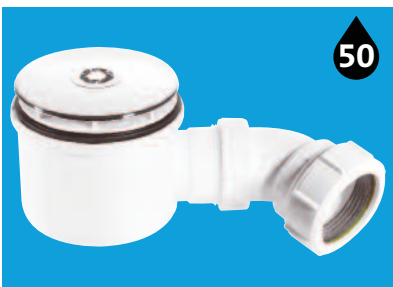

50

**90mm x 50mm Water Seal with 2" Universal Compression Outlet**  
High-flow high-performance trap. Overall height 90mm

ST90CP10-HP

ST90CB10-HP

ST90CPB-P-HP



50

**90mm x 50mm Water Seal with 2" Vertical Universal Compression Outlet**  
Overall height 106mm

ST90CP10-V

ST90CB10-V

ST90CPB-P-V

facilitate easy cleaning



CP Brass Flange



White Plastic Flange

ST90CPB-S-53

-

ST90CPB-S-70

ST90WH10-70

ST90CPB-S-HP2

ST90WH10-HP2

ST90CPB-S-HP\*

ST90WH10-HP\*

ST90CPB-S-V

ST90WH10-V

Flow Rates

All M<sup>c</sup>Alpine shower traps with top access surpass the minimum required flow rate when tested in accordance with clause 5 of BS EN 274-2:2002.

26

Litres per minute tested under a constant 15mm Head of Water

\* NOTE: High Performance (HP) traps to suit trays with maximum thickness of 15mm

# 1½" Shower Traps with Top Access

## Traps with Standard Waste and Flange

- Waste grid and dip tube removable from top to facilitate easy cleaning
- 70mm or 85mm standard waste and flange - white plastic, CP plastic or CP brass
- Gold plated wastes and grids only supplied as separate items - see page 29



70mm White Plastic Flange



85mm White Plastic Flange

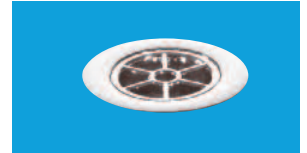

70mm CP Plastic Flange

1½" Shower Traps with Top Access



26 50

**19mm Water Seal Trap with 1½" Universal Compression Outlet**  
Overall height 95mm

STW1-R

STW5-R

STW3-R



22 40

**20mm Water Seal Trap with 1½" Solvent Weld Outlet Socket**  
Overall height 65mm

-

-

STW4-65



22 40

**50mm Water Seal Trap with 1½" Multifit Outlet**  
Overall height 95mm

STW2-95

STW6-95

STW4-95



26 54

**50mm Water Seal Resealing Trap with 1½" Multifit Outlet**  
Overall height 118mm

STW2-R

STW6-R

STW4-R



26 56

**80mm Water Seal Resealing Trap with 1½" Multifit Outlet**  
Overall height 154mm

-

-

STW10-R



85mm CP  
Plastic Flange

STW7-R



70mm CP  
Brass Flange

STW3-RB



85mm CP  
Brass Flange

STW7-RB

**Flow Rates**

All MCApine shower traps with top access surpass the minimum required flow rate when tested in accordance with clause 5 of BS EN 274-2:2002.

**26**

Litres per minute tested under a constant **15mm Head of Water**

**52**

Litres per minute tested under a constant **120mm Head of Water**

-

-

-

Code **STW4-R**

STW8-95

STW4B-95

STW8B-95

STW8-R

STW4-RB

STW8-RB

-

-

-

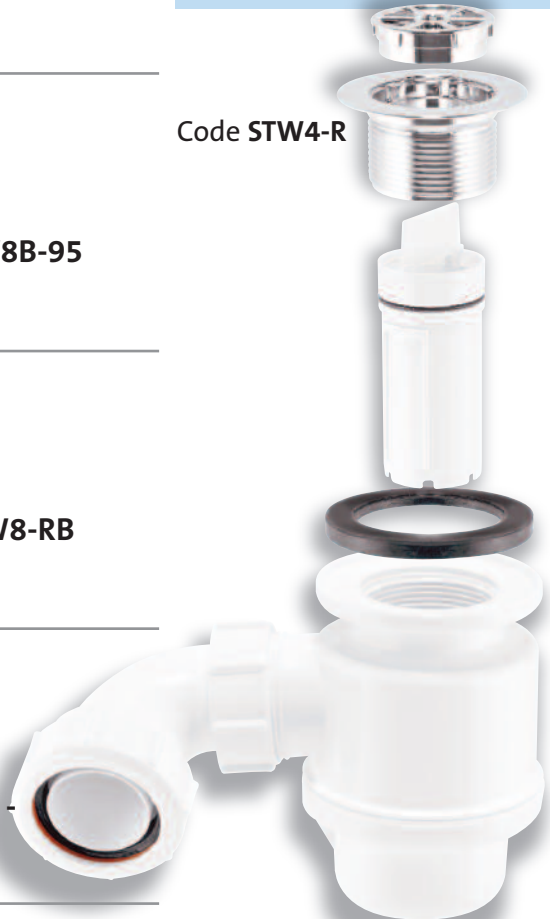

**1 1/2" Shower Traps with Top Access**



# 1½" Shower Traps with Top Access

## Traps with Waste and Mushroom Flange

- Mushroom flange and dip tube removable from top to facilitate easy cleaning
- 70mm or 85mm mushroom flange available in white plastic or CP stainless steel complete with standard locking nut



70mm White Plastic Mushroom Flange



85mm White Plastic Mushroom Flange

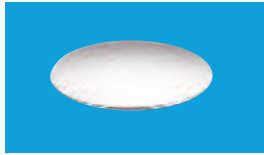

70mm CP Stainless Steel Mushroom Flange

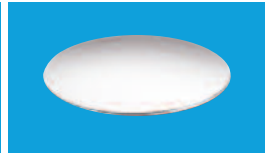

85mm CP Stainless Steel Mushroom Flange



### 19mm Water Seal Trap with 1½" Universal Compression Outlet

Overall height 95mm

26 50

STW1-M

STW5-M

STW3-M

STW7-M



### 50mm Water Seal Trap with 1½" Multifit Outlet

Overall height 95mm

22 40

STW2M-95

STW6M-95

STW4M-95

STW8M-95



### 50mm Water Seal Resealing Trap with 1½" Multifit Outlet

Overall height 118mm

26 54

STW2-M

STW6-M

STW4-M

STW8-M

#### Flow Rates

All MCApine shower traps with top access surpass the minimum required flow rate when tested in accordance with clause 5 of BS EN 274-2:2002.

26

Litres per minute tested under a constant 15mm Head of Water

52

Litres per minute tested under a constant 120mm Head of Water

1½" Shower Traps with Top Access



**70mm x 25mm Water Seal Trap with Top Access: 85mm CP Stainless Steel Mushroom Flange** with 1½" BS EN 1329-1:2000 solvent weld outlet socket. Overall height 50mm

Code **ST70SS85**

■ Only suitable for shower trays with a 70mm waste outlet

**Standard Waste** with grid to suit tray with maximum thickness of 22mm



White Plastic  
STW70WH  
STW85WH



CP Plastic  
STW70CP  
STW85CP

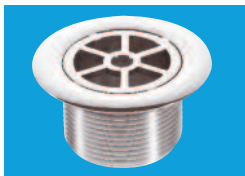

CP Brass  
STW70CPB  
STW85CPB



GP Plastic  
STW70GP  
STW85GP

**Long Waste** with grid to suit tray with maximum thickness of 29mm



White Plastic  
STW70WHL  
STW85WHL



CP Plastic  
STW70CPL  
STW85CPL

**Grid only**



White Plastic  
STWGR-WH



CP Plastic  
STWGR-CP

**Standard Locking Nut** to suit tray with maximum thickness of 22mm



White Plastic  
STW70LN  
STW85LN

**Long Locking Nut** to suit tray with maximum thickness of 29mm



White Plastic  
STW70LNL  
STW85LNL

**Mushroom Flange**



White Plastic  
STW70WHM  
STW85WHM



CP Stainless Steel  
STW70SSM  
STW85SSM

## Trap Washers, Bath and Shower Trap Accessories



1¼" Code	1½" Code	2" Code
<b>Trap Inlet</b>		
<b>RW1</b>	<b>RW2</b>	<b>RW3</b>



<b>Multifit Rubber Olive</b>		
<b>RWM1</b>	<b>RWM2</b>	<b>RWM3</b>

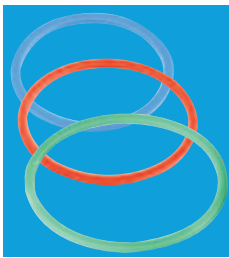

<b>Multifit Plastic Friction Washer</b>		
Blue	Red	Green
<b>PWM1</b>	<b>PWM2</b>	<b>PWM3</b>

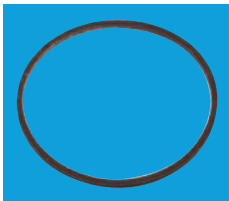

<b>Rubber Washer</b>	
For A10 CUP	<b>ARW10</b>
For C10 CUP	<b>CRW10</b>
For E10 CUP	<b>RW3</b>

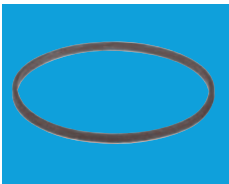

<b>Rubber Seal</b> to suit ST90 dip tube
<b>P-RW-STW90</b>



<b>Rubber 'O' Ring Seal</b> to suit STW dip tube
<b>P-OR-SHOWERTRP</b>



<b>Dip Tube</b> to suit STW trap
19mm water seal
<b>STW19-TUBE</b>
50mm water seal
<b>STW50-TUBE</b>
80mm water seal
<b>STW80-TUBE</b>



<b>110mm CP Plastic Flange</b> to suit ST90CP10-70, ST90CB10-70 and ST90WH10-70 traps
<b>ST90MECPTOP+SUPP</b>



<b>HC2650UK Extension Kit</b> will lower the HC2650UK trap waste outlet position in a bath which has a thicker reinforced base board or frame
<b>HC2650-EXT-KIT</b>



# Shower and Floor Gullies Channel Drain and Tile Drain



## SECTION 2



Shower and Floor Gullies, Channel Drain and Tile Drain



# General Information

## Shower and Floor Gullies

- M<sup>C</sup>Alpine has responded to market conditions and customer demand by producing an extensive range of gullies suitable for shower and wet floor areas
- The comprehensive range of gullies is suitable for concrete and suspended timber floors finished with sheet flooring, tiles or stone
- Two-piece gullies enable the gully to be plumbed prior to installation of timber floors and wet room floor formers
- M<sup>C</sup>Alpine gullies are ideal for domestic wet rooms, Lifetime Homes, disabled adaptations, student accommodation, bathroom pods, hotels, hospitals, secure accommodation and sport and leisure facilities
- Manufactured in ABS to the highest quality, M<sup>C</sup>Alpine gullies comply to EN 1253-2:2003
- Flow rates of 48 litres per minute exceed the minimum requirement of EN 1253-2:2003 and are variable dependent on the grating or cover plate used
- Range of Trapped Shower Gullies (TSG) available with 50mm, 60mm and 75mm water seal, Untrapped Shower Gullies (USG) for use with pumped waste and Valve Shower Gullies (VSG) for use in floors where depth is restricted
- Choice of horizontal or vertical outlet
- All gullies have top access for easy cleaning
- Choice of white plastic, polished stainless steel and chrome plated finishes for tiles, gratings, clamp rings and cover plates

## Channel Drain for Tiled Floors

- The Channel Drain is suitable for concrete and suspended timber floors finished with tiles or stone
- Manufactured in grade 304 stainless steel
- Choice of brushed or polished finish cover plate reversible to accommodate tiles up to 8mm
- Frame height adjustable to suit tiles up to 16mm

## Tile Drain for Wet Floor Areas

- The Tile Drain is suitable for concrete and suspended timber floors finished with tiles or stone
- Manufactured in grade 304 stainless steel
- Choice of 150mm square stainless steel designer tiles reversible to accommodate tiles up to 8mm
- Frame height adjustable to suit tiles up to 16mm



Code TSG50T6SS

### Sheet Flooring

- ① Choice of cover plates with or without securing screws
- ② Cover plate and dip tube assembly. Choice of cover plate finishes available
- ③ Removable sediment cup
- ④ Temporary cover plate. For use during installation as a plug for preliminary air test. Will protect gully from damage by foot traffic and prevent site debris entering the drainage system
- ⑤ Clamp ring with 4 x M6 stainless steel screws
- ⑥ Four indentations suitable for size 8 countersunk screws
- ⑦ Gully body with 2" BS EN 1329-1:2000 solvent weld horizontal outlet
- ⑧ 2" x 1½" BS EN 1329-1:2000 socket reducer



### Tile or Stone Floors

- ① Choice of tiles and gratings with or without securing screws
- ② Removable dip tube
- ③ Removable sediment cup
- ④ Dust cap/extension ring. For use during installation to prevent site debris entering the drainage system. The fitting can also be used for raising the height of the tile
- ⑤ Clamp ring for waterproofing membrane and solvent welding tile. The clamp ring has weep holes to allow any moisture at this level to discharge back into the gully and is secured by 4 x M6 stainless steel screws
- ⑥ Four indentations suitable for size 8 countersunk screws
- ⑦ Gully body with 110mm vertical outlet
- ⑧ 110mm x 2" BS EN 1329-1:2000 solvent weld reducer

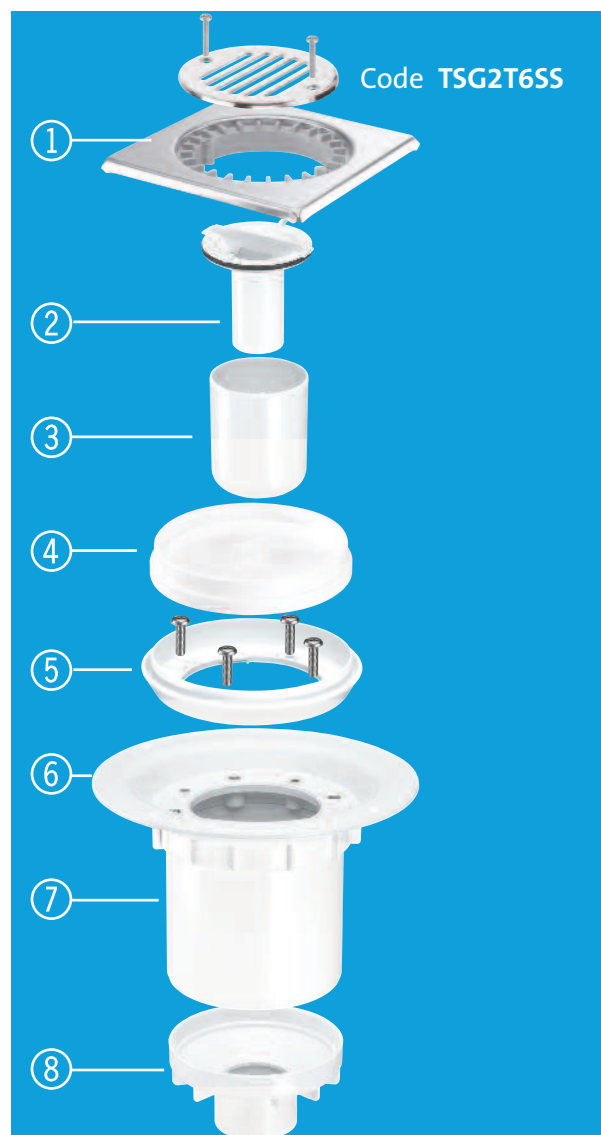

■ The two products shown illustrate the versatility of the McAlpine range of Trapped Shower Gullies. See pages 34-38 for the full range of Trapped and Untrapped Gullies

# Gullies for use with Sheet Flooring

## Trapped Gullies

Choose the appropriate gully body and cover plate finish required

White Plastic  
Clamp Ring and  
Cover Plate

Polished  
Stainless Steel  
Clamp Ring and  
Cover Plate

CP Brass Clamp  
Ring, CP  
Stainless Steel  
Grated Cover  
Plate

Gullies without securing screws allow for easier access

Do not pour drain cleaner down these products



**75mm Water Seal Trap** with 2" BS EN 1329-1:2000 solvent weld horizontal outlet and 2" x 1½" socket reducer. Overall height 130mm



With  
securing  
screws

**TSG1-WH**

**TSG1SS**

**TSG1SS-SL-SC**

Without  
securing  
screws

**TSG1WH-NSC**

-

**TSG1SS-SL-NSC**

**50mm Water Seal Trap** with 2" BS EN 1329-1:2000 solvent weld horizontal outlet and 2" x 1½" socket reducer. Overall height 100mm



With  
securing  
screws

**TSG50WH**

**TSG50SS**

**TSG50SS-SL-SC**

Without  
securing  
screws

**TSG50WH-NSC**

-

**TSG50SS-SL-NSC**

**Two-Piece Gully, 50mm Water Seal Trap** with 2" BS EN 1329-1:2000 solvent weld horizontal outlet, 2" swivel outlet fitting and 2" x 1½" socket reducer. Overall height 100mm



With  
securing  
screws

**TSG52WH**

**TSG52SS**

**TSG52SS-SL-SC**

Without  
securing  
screws

**TSG52WH-NSC**

-

**TSG52SS-SL-NSC**

**75mm Water Seal Trap** with 110mm vertical outlet and 110mm x 2" BS EN 1329-1:2000 solvent spigot outlet. Overall height 130mm



With  
securing  
screws

**TSG2WH**

**TSG2SS**

**TSG2SS-SL-SC**

Without  
securing  
screws

**TSG2WH-NSC**

-

**TSG2SS-SL-NSC**

Gullies for use with Sheet Flooring

**Trapped Gullies**

Choose the appropriate gully body and cover plate finish required

Gullies without securing screws allow for easier access

Do not pour drain cleaner down these products

White Plastic  
Clamp Ring and  
Cover Plate

Polished  
Stainless Steel  
Clamp Ring and  
Cover Plate

CP Brass Clamp  
Ring, CP  
Stainless Steel  
Grated Cover  
Plate



**50mm Water Seal Trap** with 1½" BS EN 1329-1:2000 solvent weld side inlet for the discharge from a wash hand basin with a 110mm vertical outlet to fit 110mm pipe socket or vertical 1½" solvent weld pipework. Overall height 130mm



With  
securing  
screws

**TSG3-WH**

**TSG3SS**

**TSG3SS-SL-SC**

Without  
securing  
screws

-

-

**TSG3SS-SL-NSC**

Gullies show white cover plates for illustrative purposes only

**Untrapped Gullies**

**Untrapped Gully** with 22mm horizontal plain outlet for use with pumped waste. Overall height 44.5mm



With  
securing  
screws

**USG1WH**

**USG1SS**

**USG1SS-SL-SC**

**Untrapped Gully** with 2" BS EN 1329-1:2000 solvent weld vertical outlet and 2" x 1½" socket reducer. Overall height 70.5mm



With  
securing  
screws

**USG2WH**

**USG2SS**

**USG2SS-SL-SC**

**Untrapped Gully** with 1½" BS EN 1329-1:2000 solvent weld horizontal outlet. Overall height 70.5mm



With  
securing  
screws

**USG3WH**

**USG3SS**

**USG3SS-SL-SC**

Gullies show white cover plates for illustrative purposes only. See page 52 for gully flow rates



# Gullies for use with Tiled or Stone Floors where a Waterproofing

## Trapped Gullies

Choose the appropriate gully body and cover plate finish required

Gullies without securing screws allow for easier access

Do not pour drain cleaner down these products

150mm Square Polished Stainless Steel Tile with removable Grid

150mm Square White ABS Tile with removable Grid

125mm Diameter Polished Stainless Steel Grating with removable Grid

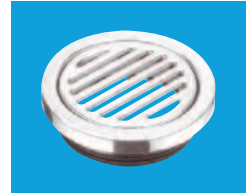
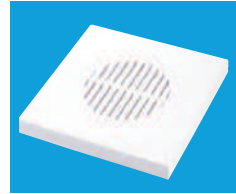

**75mm Water Seal Trap** with 2" BS EN 1329-1:2000 solvent weld horizontal outlet and 2" x 1½" socket reducer. Overall height 130mm



With securing screws

**TSG1T6SS**

-

-

Without securing screws

**TSG1-T150SS**

**TSG1T6WH**

**TSG1-R125SS**

**50mm Water Seal Trap** with 2" BS EN 1329-1:2000 solvent weld horizontal outlet and 2" x 1½" socket reducer. Overall height 100mm



With securing screws

**TSG50T6SS**

-

-

Without securing screws

**TSG50-T150SS**

**TSG50T6WH**

**TSG50-R125SS**

**Two-Piece Gully, 50mm Water Seal Trap** with 2" BS EN 1329-1:2000 solvent weld horizontal outlet, 2" swivel outlet fitting and 2" x 1½" socket reducer. Overall height 100mm



With securing screws

**TSG52T6SS**

-

-

Without securing screws

**TSG52-T150SS**

**TSG52T6WH**

**TSG52-R125SS**

**75mm Water Seal Trap** with 110mm vertical outlet and 110mm x 2" BS EN 1329-1:2000 solvent spigot outlet. Overall height 130mm



With securing screws

**TSG2T6SS**

-

-

Without securing screws

**TSG2-T150SS**

**TSG2T6WH**

**TSG2-R125SS**

Gullies show square stainless steel cover plates for illustrative purposes only. All above gullies supplied with white plastic clamp ring. See page 52 for gully flow rates

### Untrapped Gullies

Choose the appropriate gully body and cover plate finish required

Gullies without securing screws allow for easier access

Do not pour drain cleaner down these products

150mm Square Polished Stainless Steel Tile with removable Grid

150mm Square White ABS Tile with removable Grid

125mm Diameter Polished Stainless Steel Grating with removable Grid

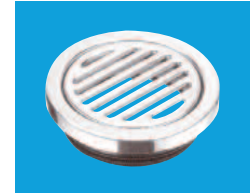
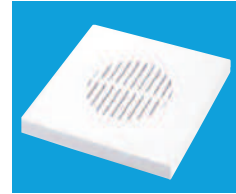

**Untrapped Gully** with 22mm horizontal plain outlet for use with pumped waste. Overall height 44.5mm



With securing screws

**USG1T6SS**

-

-

Without securing screws

**USG1-T150SS**

-

-

**Untrapped Gully** with 2" BS EN 1329-1:2000 solvent weld vertical outlet and 2" x 1½" socket reducer. Overall height 70.5mm



With securing screws

**USG2T6SS**

-

-

Without securing screws

**USG2-T150SS**

-

-

**Untrapped Gully** with 1½" BS EN 1329-1:2000 solvent weld horizontal outlet. Overall height 70.5mm



With securing screws

**USG3T6SS**

-

-

Without securing screws

**USG3-T150SS**

-

-

## Two-Piece Gully and Gully with Non-Return Valve

- Two-piece gullies have been specifically designed for use with timber floors and floor formers and can be plumbed prior to the installation of the floor or former. See pages 34-40 for product range
- The Valve Shower Gully (VSG) has been developed to satisfy customer demand for a shallow gully suitable for installation in floors where depth is restricted



Code **VSG1WH-NSC**

# Gullies with Non-Return Valve for use where floor depth is restricted

## SECTION 2

- The Valve Shower Gully (VSG) has been developed to satisfy customer demand for a shallow gully suitable for installation in floors where depth is restricted
- The overall height of the VSG1 is only 75mm and the valve is a substitute for a regulatory water seal trap which cannot be incorporated in a gully of this height
- There are currently no regulations to cover the use of anything other than water seal traps in domestic drainage systems. Although valves have been in existence for some time, it is advisable to seek guidance from the local building control department prior to use
- The valve acts as a non-return valve, the weight of the water discharge will open the valve and it will reseal when the discharge has ceased thus prohibiting foul air from entering the dwelling
- The valve eliminates the release of foul air due to back flow
- The valve can be easily removed to facilitate easy cleaning of the gully
- The VSG range has a minimum flow rate of 30 litres per minute when tested with a 15mm head of water



**White Plastic Clamp Ring with Cover Plate** and 1½" BS EN 1329-1:2000 solvent weld horizontal outlet. Overall height 75mm

	Code
With securing screws	<b>VSG1WH</b>
Without securing screws	<b>VSG1WH-NSC</b>



**Two-Piece Gully, White Plastic Clamp Ring with Cover Plate** and 1½" BS EN 1329-1:2000 solvent weld horizontal outlet. Overall height 85mm

With securing screws	<b>VSG52WH</b>
----------------------	----------------



**150mm Square Polished Stainless Steel Tile with removable Grid and Securing Screws** 1½" BS EN 1329-1:2000 solvent weld horizontal outlet. Overall height 75mm

	<b>VSG1T6SS</b>
--	-----------------

See page 52 for gully flow rates

**Gullies without securing screws allow for easier access**

**Do not pour drain cleaner down these products**



## Gullies with Non-Return Valve for use where floor depth is restricted



### Two-Piece Gully, 150mm Square Polished Stainless Steel Tile with removable Grid and Securing Screws

1½" BS EN 1329-1:2000 solvent weld horizontal outlet.  
Overall height 85mm

Code

VSG52T6SS

## Gullies with Anti-Ligature Grating for use with Sheet Flooring

- Shower gullies with anti-ligature grating have been designed for use in secure accommodation
- Grating is Home Office approved
- All gullies supplied with security screwdriver bit to release anti-ligature grating



**75mm Water Seal Trap** 2" BS EN 1329-1:2000 solvent weld horizontal outlet and 2" x 1½" socket reducer. CP brass clamp ring with polished stainless steel anti-ligature grating.  
Overall height 130mm

Code

TSG1-ANTI/LIG



**50mm Water Seal Trap** 2" BS EN 1329-1:2000 solvent weld horizontal outlet and 2" x 1½" socket reducer. CP brass clamp ring with polished stainless steel anti-ligature grating.  
Overall height 100mm

Code

TSG50-ANTI/LIG



**Two-Piece Gully, 50mm Water Seal Trap** 2" BS EN 1329-1:2000 solvent weld horizontal outlet, 2" swivel outlet fitting and 2" x 1½" socket reducer. CP brass clamp ring with polished stainless steel anti-ligature grating.  
Overall height 100mm

Code

TSG52-ANTI/LIG



**75mm Water Seal Trap** with 110mm vertical outlet and 110mm x 2" BS EN 1329-1:2000 solvent weld reducer. CP brass clamp ring with polished stainless steel anti-ligature grating.  
Overall height 130mm

Code

TSG2-ANTI/LIG

# Top Access Shower Traps for use with Sheet Flooring, Tiled or Stone Floors

## SECTION 2



### For Sheet Flooring

**19mm Water Seal Trap** with 1½" universal compression outlet, white plastic clamp ring and cover plate with securing screws.  
Overall height 138mm

Code

TSG1WH-STW1R



### For Sheet Flooring

**50mm Water Seal Trap** with 1½" x 90° swivel Multifit outlet bend, white plastic clamp ring and cover plate with securing screws.  
Overall height 138mm

Code

TSG1WHSTW295



### For Sheet Flooring

**50mm Water Seal Resealing Trap** with 1½" x 90° swivel Multifit outlet bend, white plastic clamp ring and cover plate with securing screws.  
Overall height 167mm

Code

TSG1WH-STW2R



### For Tiled or Stone Floors

**19mm Water Seal Trap** with 1½" universal compression outlet, 150mm square polished stainless steel tile with removable grid and securing screws.  
Overall height 138mm

Code

TSG1T6SS+STW1-R



### For Tiled or Stone Floors

**50mm Water Seal Trap** with 1½" x 90° swivel Multifit outlet bend, 150mm square polished stainless steel tile with removable grid and securing screws.  
Overall height 138mm

Code

TSG1T6SSSTW295



### For Tiled or Stone Floors

**50mm Water Seal Resealing Trap** with 1½" x 90° swivel Multifit outlet bend, 150mm square polished stainless steel tile with removable grid and securing screws.  
Overall height 167mm

Code

TSG1T6SS-STW2R

# Tiles and Gratings

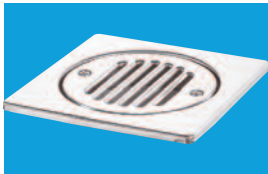

**150mm Square Polished Stainless Steel Tile** with removable grid and securing screws. Tile has ABS spigot adaptor for solvent welding to clamp ring

Code

**FGTOP6SS**

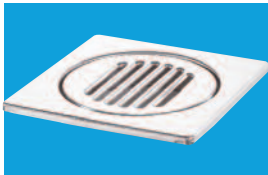

**150mm Square Polished Stainless Steel Tile** with removable grid. Tile has a removable ABS spigot adaptor for solvent welding to clamp ring leaving a rubber gasket to fit inside 110mm pipe

Code

**FGT150TOP**

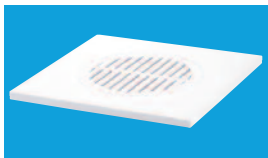

**150mm Square White ABS Tile** with removable grid. Tile has spigot adaptor for solvent welding to clamp ring

Code

**MDTOP-WH**



**200mm Square White ABS Tile** with removable grid. Tile has spigot adaptor for solvent welding to clamp ring

Code

**MDTOP20-WH**



**125mm Diameter Polished Stainless Steel Grating** with removable grid. Grating has a removable ABS spigot adaptor for solvent welding to clamp ring leaving a rubber gasket to fit inside 110mm pipe. Suitable for stone shower bases

Code

**FGTR125STOP**

## 150mm Stainless Steel Tile with Internal Non-Return Valve

- Suitable for wet floor areas where 4"/110mm drainage pipework has been installed to the finished floor level and no waterproofing membrane is required
- The internal non-return valve prevents foul air entering the building
- The 150mm square tile can be fitted on a trapped or untrapped drain
- Ideal for replacement and repair of a damaged tile or problem systems
- Push-fit or solvent weld spigot suitable for direct connection to 4"/110mm drainage pipework
- Valve easily removed for cleaning and maintenance work

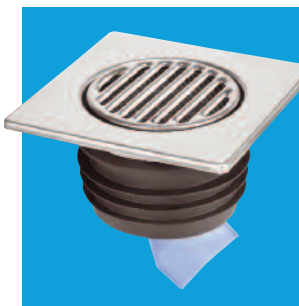

150mm square stainless steel tile with silicone non-return valve and removable grid including removable stainless steel mesh filter

Code

**FGT150-SV-110**



150mm square stainless steel tile with silicone non-return valve and securing screws. ABS solvent weld connection to 4"/110mm drainage pipework

Code

**FGT150-SV-110S**

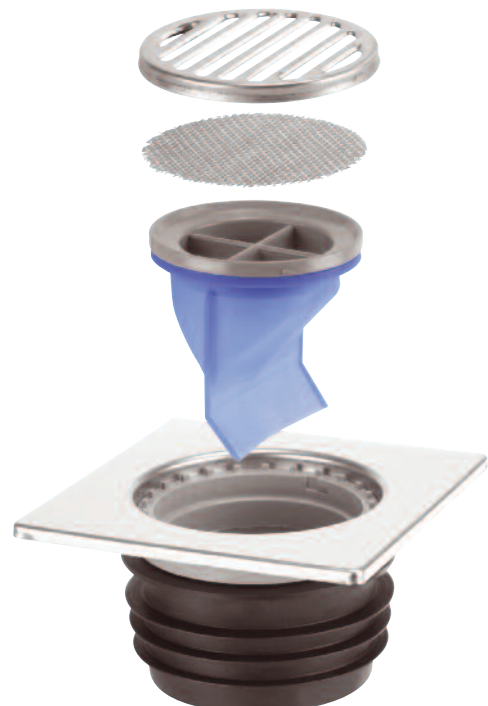

# Gullies suitable for Concrete Ground Floors where a Waterproofing Membrane is not required

## SECTION 2

### Trapped Gully Bodies



#### Multi-Drain - 60mm Water Seal Universal Trapped Floor Gully

manufactured in grey ABS with 2<sup>2</sup>/<sub>3</sub>" solvent weld horizontal outlet.

Height can be extended by solvent welding length of 110mm PVC pipe between gully body and tile. Inlet connections are for solvent welding to 1<sup>1</sup>/<sub>2</sub>" ABS/PVC pipe, internal fit or 2" ABS/PVC pipe, external fit. Overall height 152mm

For Tiles and Gratings see page 42

Code

MD100



#### Multi-Drain - 60mm Water Seal Universal Trapped Floor Gully

manufactured in grey ABS with 3" solvent weld horizontal outlet. Height can be extended by solvent welding length of 110mm PVC pipe between gully body and tile. Inlet connections are for solvent welding to 1<sup>1</sup>/<sub>2</sub>" ABS/PVC pipe, internal fit or 2" ABS/PVC pipe, external fit.

Overall height 152mm

For Tiles and Gratings see page 42

Code

MD100-3

### Adaptors for Inlet and Outlet Connections

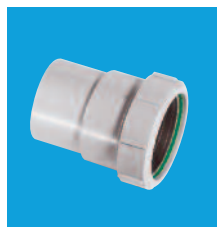

#### Multi-Drain Inlet Fitting

2" solvent weld x 2" universal compression

Code

MD200

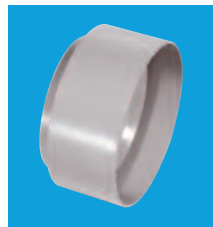

#### Multi-Drain Outlet Fitting

3" solvent weld x 110mm solvent weld

Code

MD400

### Untrapped Gullies with Top Access for Tiled Floors



**Untrapped Gully** with 1<sup>1</sup>/<sub>2</sub>" BS EN 1329-1:2000 solvent weld horizontal outlet and 150mm square polished stainless steel tile with removable grid and securing screws.

Overall height 68mm

Code

FD90-T6SS



**Untrapped Gully** with 1<sup>1</sup>/<sub>2</sub>" BS EN 1329-1:2000 solvent weld horizontal outlet and 150mm square white ABS tile with removable grid.

Overall height 68mm

Code

FD90-T6WH

*Do not pour drain cleaner down these products*



# Channel Drain for Tiled Floors

- Supplied with 1½" x 50mm water seal trap with top access for easy cleaning
- Available with polished or brushed finished grade 304 stainless steel cover plate
- Cover plate reversible to accommodate tiles up to 8mm
- Frame height adjustable to suit tiles up to 16mm
- Flow rate 54 litres per minute. Calculated under a constant 120mm head of water
- Supplied with adjustable height support legs for concrete floor installations. Adjustable height 128-170mm
- There are two MCAAlpine ranges: Standard and Slimline channel drains. Both are available in a choice of lengths, designs and finishes

## Standard Channel Drain for Tiled Floors

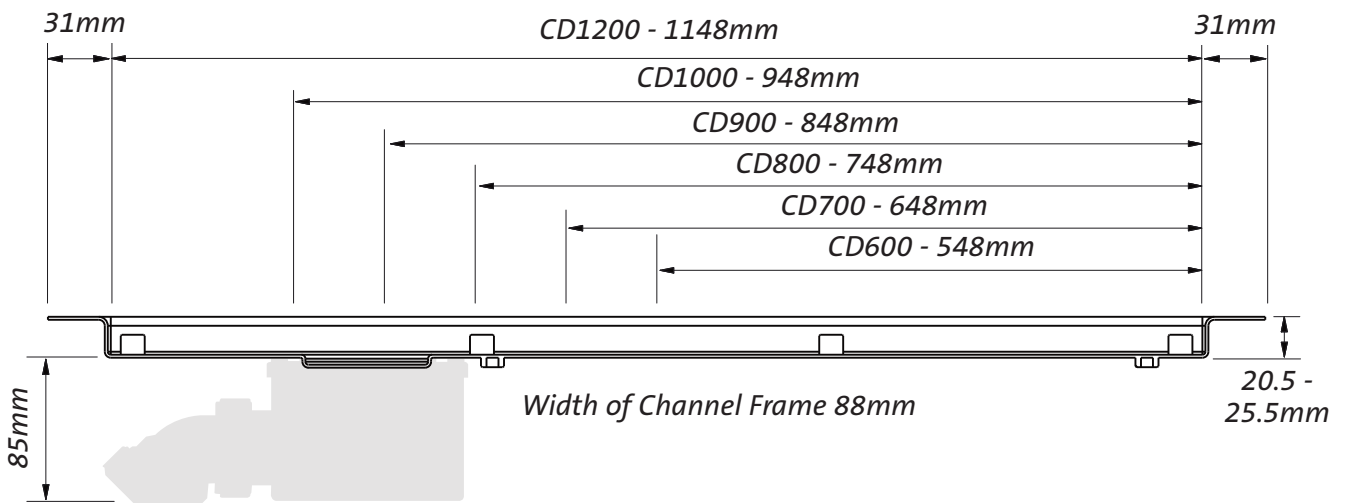

Channel Drain for Tiled Floors



*Do not pour drain cleaner down these products*

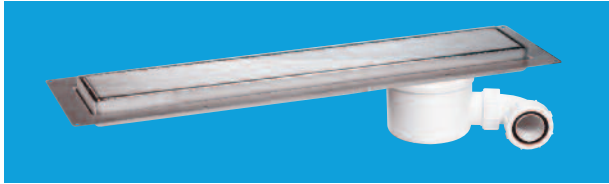

**Standard Channel Drain** with brushed finish cover plate

Code	<b>CD600-B</b>
Code	<b>CD700-B</b>
Code	<b>CD800-B</b>
Code	<b>CD900-B</b>
Code	<b>CD1000-B</b>
Code	<b>CD1200-B</b>

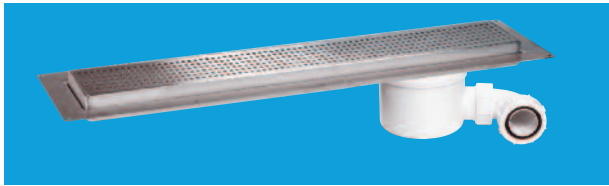

**Standard Channel Drain** with grid (brushed finish)

Code	<b>CD600-SQ</b>
Code	<b>CD700-SQ</b>
Code	<b>CD800-SQ</b>
Code	<b>CD900-SQ</b>
Code	<b>CD1000-SQ</b>
Code	<b>CD1200-SQ</b>



**Standard Channel Drain** with polished finish cover plate

Code	<b>CD600-P</b>
Code	<b>CD700-P</b>
Code	<b>CD800-P</b>
Code	<b>CD900-P</b>
Code	<b>CD1000-P</b>
Code	<b>CD1200-P</b>

*Cover plates available separately on request*



Scan here to view our Installation video or visit our website [www.mcalpineplumbing.com](http://www.mcalpineplumbing.com)



*Do not pour drain cleaner down these products*

# Channel Drain for Tiled Floors

## Slimline Channel Drain for Tiled Floors

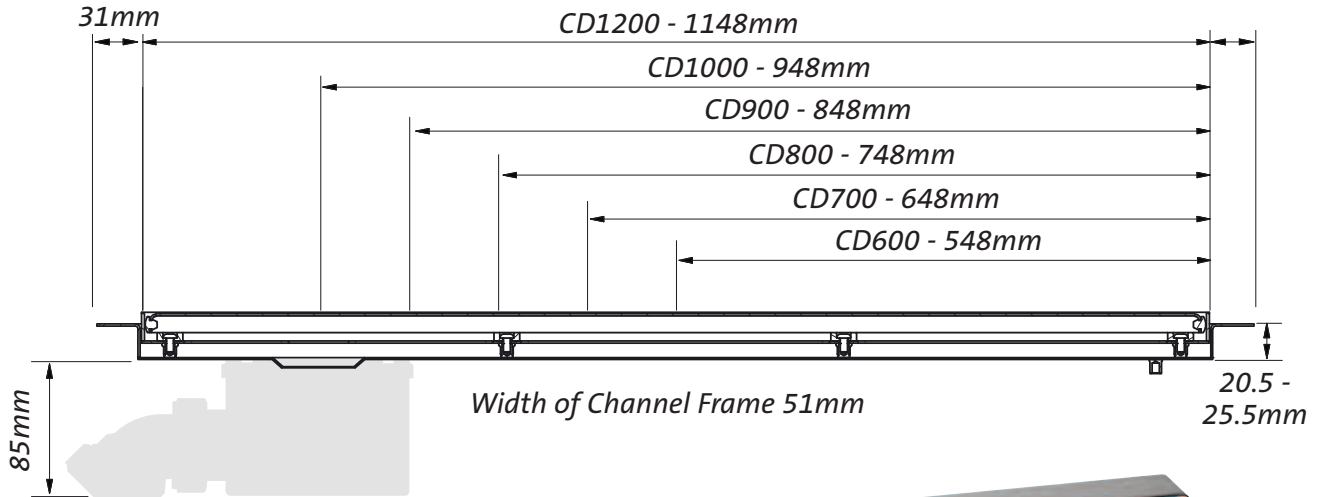

Channel Drain for Tiled Floors



**Slimline Channel Drain** with brushed finish cover plate

Code	<b>CD600-O-B</b>
Code	<b>CD700-O-B</b>
Code	<b>CD800-O-B</b>
Code	<b>CD900-O-B</b>
Code	<b>CD1000-O-B</b>
Code	<b>CD1200-O-B</b>

*Cover plates available separately on request*



**Slimline Channel Drain** with polished finish cover plate

Code	<b>CD600-O-P</b>
Code	<b>CD700-O-P</b>
Code	<b>CD800-O-P</b>
Code	<b>CD900-O-P</b>
Code	<b>CD1000-O-P</b>
Code	<b>CD1200-O-P</b>

*Do not pour drain cleaner down these products*

- Tiles suitable for 50mm water seal traps as illustrated
- Tiles supplied with brushed or polished finish. All in grade 304 stainless steel
- Tiles reversible to accommodate tiles up to 8mm
- Tile frame dimension 150mm square
- Frame height adjustable to suit tiles up to 16mm
- Supplied with adjustable height support legs for concrete floor installations



Code **TILE-PLAIN-B**

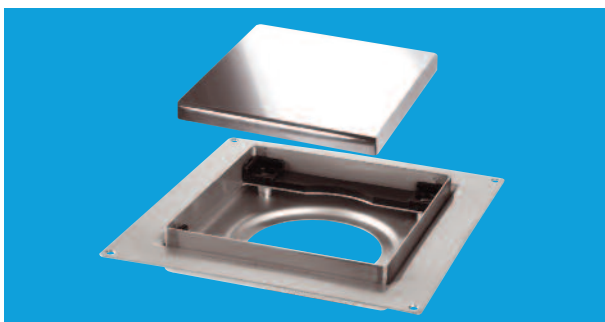

Code **TILE-PLAIN-P**



**50mm Water Seal Trap Body** with 1½" Multifit outlet. Adjustable height 105-168mm. Flow rate 34 l/min\*

Code **ST90-70B**



**50mm Water Seal Trap Body** with 1½" Multifit outlet. Adjustable height 120-168mm. Flow rate 42 l/min\*

Code **ST90-HP2B**



**50mm Water Seal Trap Body** with 2" Multifit outlet. Adjustable height 120-168mm. Flow rate 50 l/min\*

Code **ST90-HPB**

Tile Drain for Wet Floor Areas

\*Flow rate calculated under a constant 15mm head of water

Do not pour drain cleaner down these products



# Installation Guidelines

## General Notes and Guidance for Shower Gullies

- All Trapped (TSG), Untrapped (USG) and Valve (VSG) shower gullies can be used in concrete or suspended timber floors
- All gullies are ideal for shower and wet floor areas
- Fixing instructions are supplied with each gully

## Sheet Flooring

- Set the gully into the floor and ensure that the top surface of the gully flange is flush with, or slightly below, the floor surface on which the flooring is to be laid
- Ensure the gully body is fully supported, do not rely solely on the gully flange for support
- A watertight seal between the underside of the sheet flooring and the gully flange must be achieved with the use of a neutral sealant (not an acetoxy sealant) prior to the clamp ring being screwed into position

## Tiled Floors

- The minimum dimension between the gully flange and top surface of the gully tile or grating, which requires to be flush with the flooring, is 13mm. This dimension cannot be reduced but if required the gully tile or grating can be raised. To do this remove the centre from the dust cap/extension ring and solvent weld the extension ring to the upstand of the clamp ring. If additional height is required an appropriate length of 110mm pipe can be solvent welded between the extension ring and the underside of the gully tile or grating
- Ensure the gully body is fully supported, do not rely solely on the gully flange for support
- A good quality waterproofing membrane should be employed to prevent water penetration to the floor structure. Ensure that the underside of the membrane is sealed to the gully flange and secured by the clamp ring to the gully body
- The clamp ring has weep holes to allow any moisture to discharge into the gully

## Stone Shower Bases and Trays

- Gullies can be used with stone or marble shower bases and trays. The illustration shows how a 125mm diameter polished stainless steel grating can be connected to a 50mm water seal gully
- A waterproofing membrane should be fitted between the gully body and the underside of the base or tray

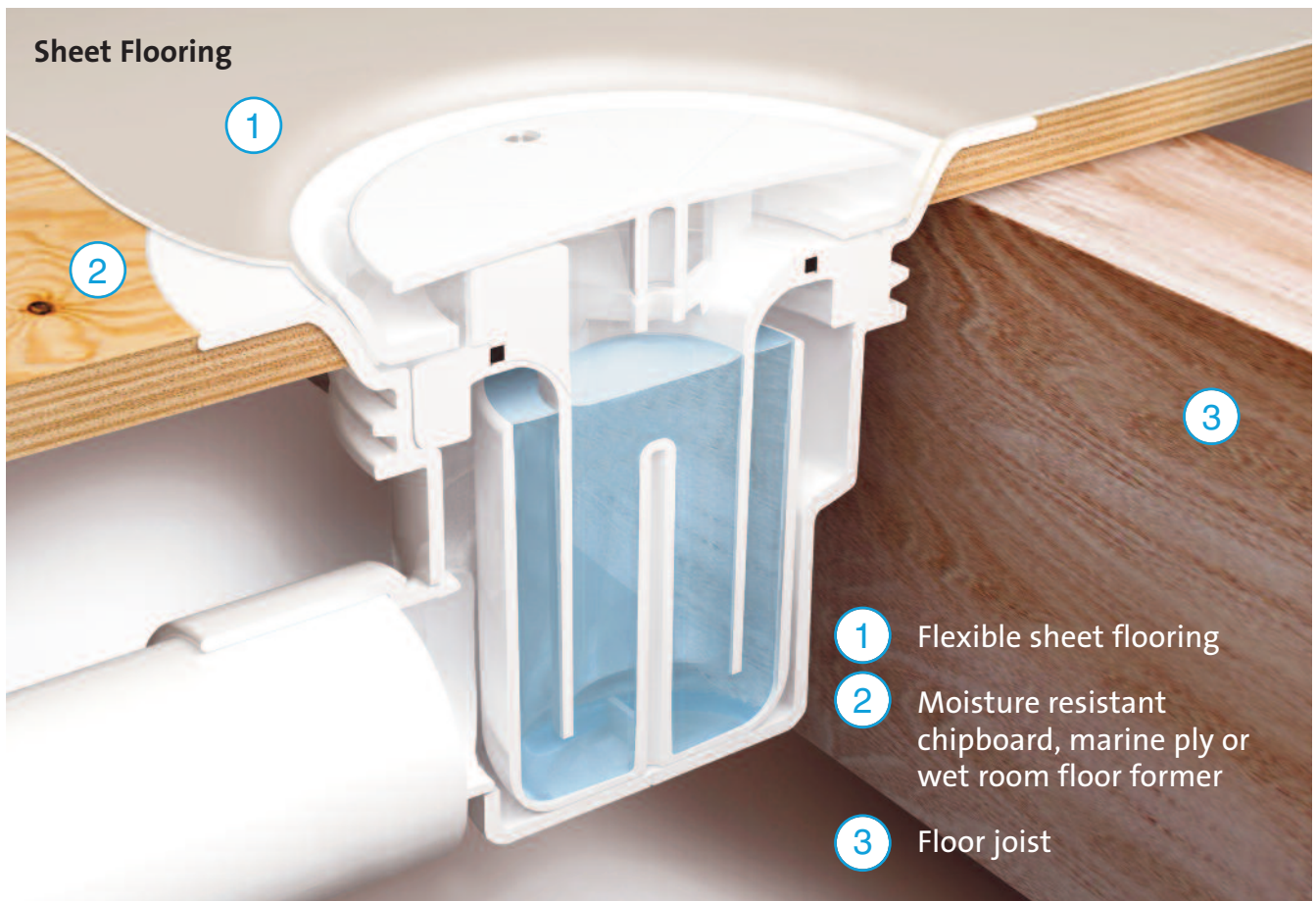



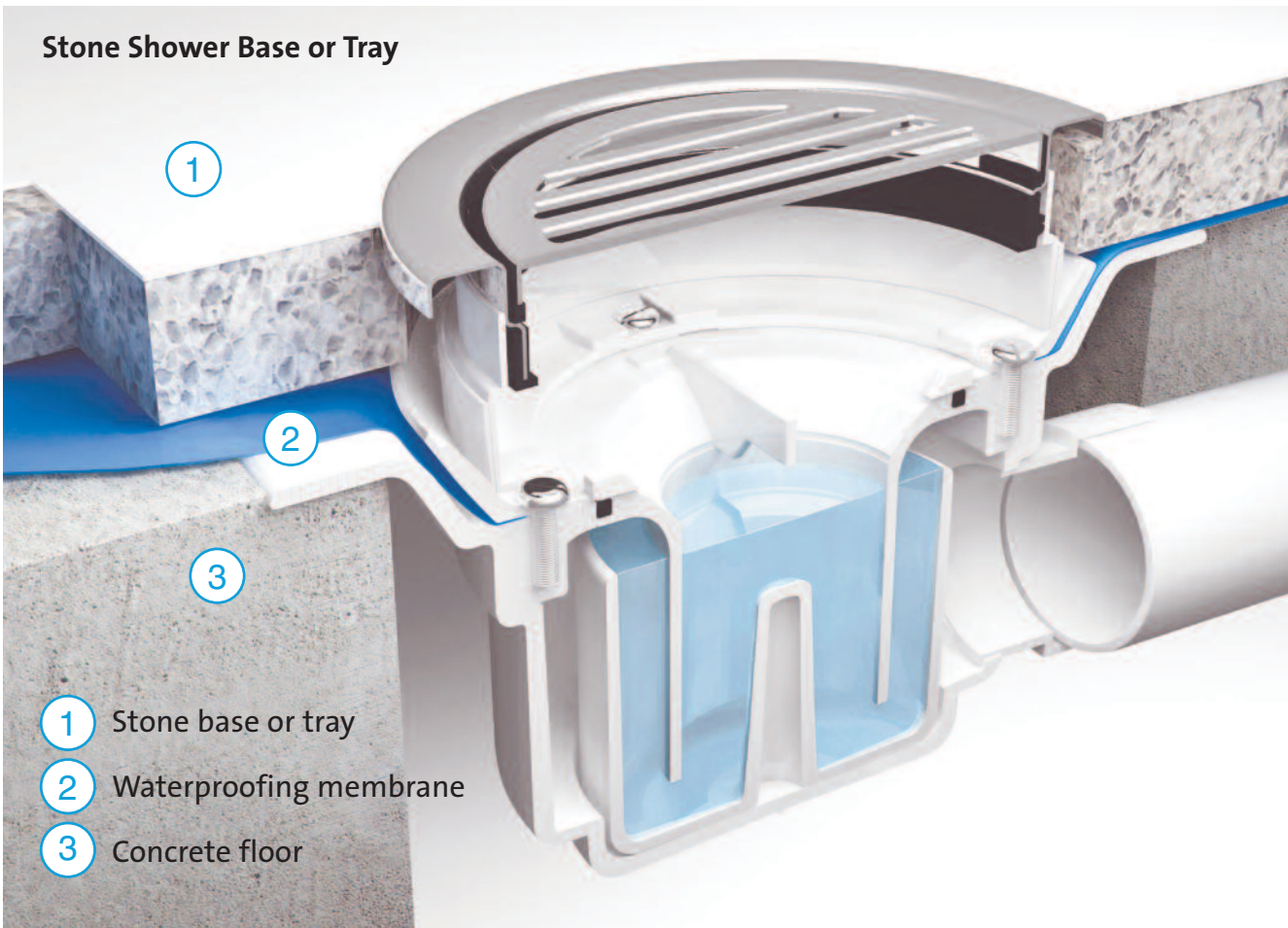
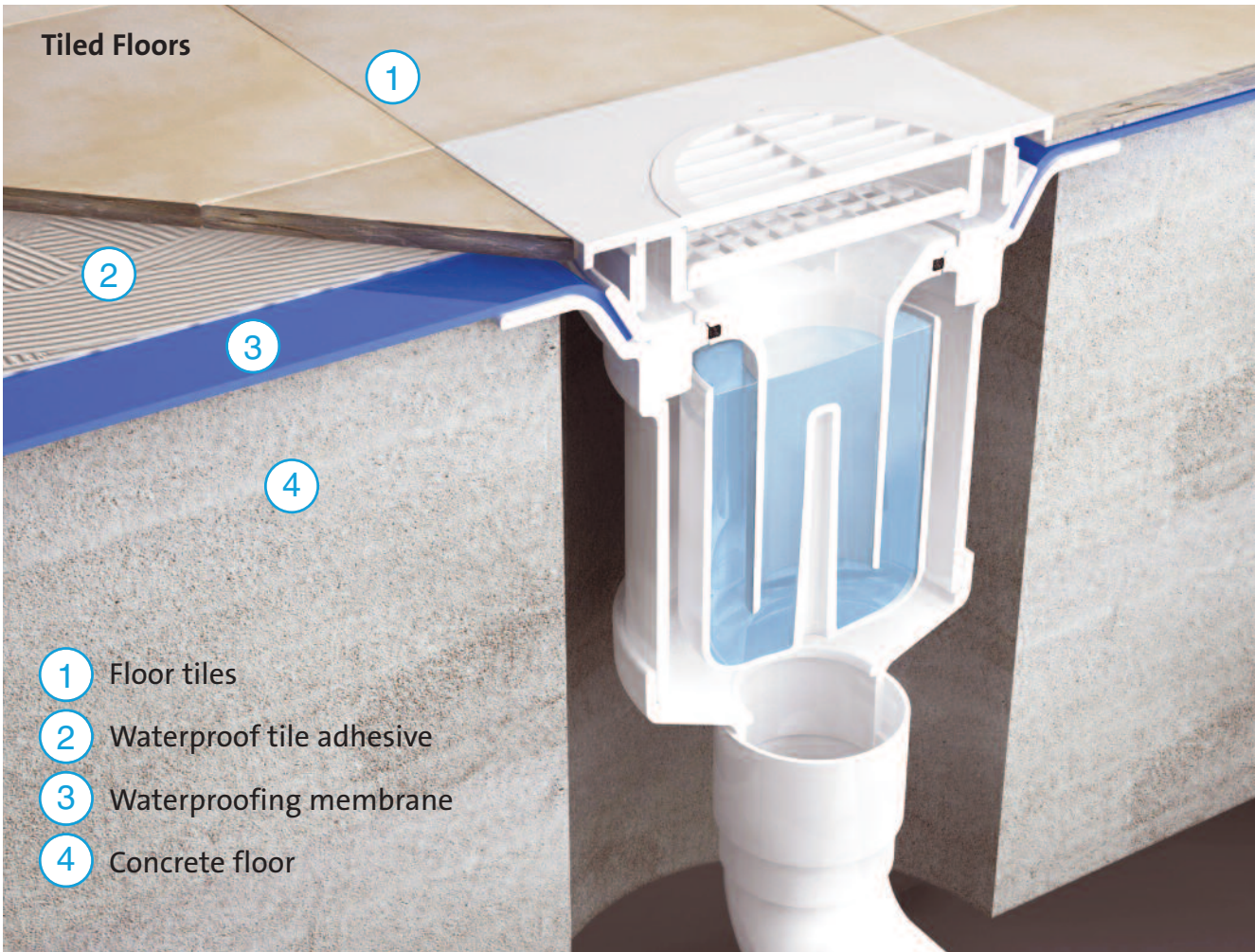

# Conversion Kits

## Conversion Cover Plate with 1½" Universal Pipe Boss



For use with TSG1, TSG50, TSG52 and TSG2 shower gullies for sheet flooring. Used to seal off gully or to convert to a drain connection to allow for installation of bath waste. By refitting the cover plate and dip tube the drain reverts to a trapped gully

Code

**CPTSG**

## Conversion Kits to enable Gullies except MD100, MD100-3 and FD90 to be converted for different floor finishes



**Converts any TSG1 or TSG2 Gully** from tiled to a sheet flooring gully with dip tube, CP brass clamp ring, CP stainless steel grated cover plate without securing screws

Code **FGTR118TOP**



**Converts any TSG1 or TSG2 Gully** to a tiled floor gully with white ABS clamp ring, 150mm square white ABS tile with removable grid and dip tube

Code **TSGCONV**



**Converts any TSG50 or TSG52 Gully** to a sheet flooring gully with dip tube, CP brass clamp ring, CP stainless steel grated cover plate with securing screws

Code **FGTR118TOP-50**



**Converts any TSG1 or TSG2 Gully** to a tiled floor gully with white ABS clamp ring, 150mm square polished stainless steel tile with removable grid, securing screws and dip tube

Code **TSGCONVSS**



**Converts any TSG1 or TSG2 Gully** to a sheet flooring gully with white plastic clamp ring, cover plate and dip tube

Code **TSGCONTV**



**Converts any TSG1 or TSG2 Gully** to a sheet flooring gully with polished stainless steel clamp ring, cover plate and dip tube

Code **TSGCONTVSS**



**Converts any Gully with a 150mm White Plastic Tile** to a gully with a 150mm square polished stainless steel tile with removable grid and securing screws

Code **FGTOP6SS**

### Stopper for TSG Dip Tubes



For use with trapped shower gullies TSG1, TSG50, TSG52 and TSG2 models only, either sheet flooring or tiled floor versions. When after installation the gully is not going to be used there is a possibility that the water seal will evaporate. The stopper when inserted into the dip tube will prevent foul air entering the building

Code

**TSGSTOP**

### Filter Mesh

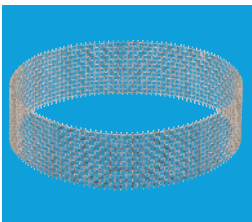

**Filter Mesh** to suit USG1 range of untrapped gullies

Code

**MESH-1**

### Stability Leg



**Optional Stability Leg** to suit USG1 range of untrapped gullies

Code

**USGLEG1**



All M<sup>c</sup>Alpine gullies surpass the minimum required flow rate when tested in accordance with clause 5 of BS EN 274-2:2002. **The flow rate is tested under a constant 15mm head of water** and will vary depending on the tile grating cover plate used.









Code	Flow Rate Litres per minute	Code	Flow Rate Litres per minute	Code	Flow Rate Litres per minute
TSG1-ANTI/LIG	31	TSG3SS-SL-NSC	>70	USG1SS-SL-SC	10
TSG1-R125SS	56.9	TSG3SS-SL-SC	>70	USG1-T150SS	10
TSG1SS	50	TSG3-T150SS	>70	USG1T6SS	10
TSG1SS-SL-NSC	53.6	TSG3T6SS	>70	USG1WH	10
TSG1SS-SL-SC	53.6	TSG3T6WH	>70	USG1WH-NSC	10
TSG1-T150SS	55	TSG3WH	65.1	USG2SS	68
TSG1T6SS	55	TSG50-ANTI/LIG	44	USG2SS-SL-NSC	68
TSG1T6SS+STW1R	35	TSG50-R125SS	54.3	USG2SS-SL-SC	68
TSG1T6SSSTW295	32	TSG50SS	48	USG2-T150SS	68
TSG1T6SS-STW2R	37	TSG50SS-SL-NSC	50.3	USG2T6SS	68
TSG1T6WH	55	TSG50SS-SL-SC	50.3	USG2WH	68
TSG1-WH	53	TSG50-T150SS	53.6	USG3SS	65
TSG1WH-NSC	53	TSG50T6SS	52.6	USG3SS-SL-NSC	65
TSG1WH-STW1R	35	TSG50T6WH	52.5	USG3SS-SL-SC	65
TSG1WHSTW295	32	TSG50WH	50.5	USG3-T150SS	65
TSG1WH-STW2R	37	TSG50WH-NSC	51	USG3T6SS	65
TSG2-ANTI/LIG	>70	TSG52-ANTI/LIG	44	USG3WH	65
TSG2-R125SS	>70	TSG52-R125SS	54.3	VSG1T6SS	30
TSG2SS	>70	TSG52SS	48	VSG1T6WH	30
TSG2SS-SL-NSC	>70	TSG52SS-SL-NSC	50.3	VSG1WH	30
TSG2SS-SL-SC	>70	TSG52SS-SL-SC	50.3	VSG1WH-NSC	30
TSG2-T150SS	>70	TSG52-T150SS	53.6	VSG52T6SS	36
TSG2T6SS	>70	TSG52T6SS	52.5	VSG52T6WH	36
TSG2T6WH	>70	TSG52T6WH	52.5	VSG52WH	36
TSG2WH	>70	TSG52WH	50.5	VSG52WH-NSC	36
TSG2WH-NSC	>70	TSG52WH-NSC	51		
TSG3-R125SS	>70	USG1SS	10		
TSG3SS	64.5	USG1SS-SL-NSC	10		





# Multifit Waste Fittings

## Multifit Waste Fittings

	1¼" Code	1½" Code	2" Code
			
<b>90° Bend</b>			
	<b>MS4</b>	<b>MT4</b>	<b>MZ4</b>
			
<b>90° Bend Multifit x European pipe size</b>			
x 32mm	x 40mm	x 50mm	
<b>MS4-ISO</b>	<b>MT4-ISO</b>	<b>MZ4-ISO</b>	
			
<b>90° Bend Multifit x 32mm European pipe size ring seal pushfit</b>			
<b>MS4-32MM</b>	-	-	
			
<b>90° Bend ABS solvent weld x 32mm European pipe size ring seal pushfit</b>			
<b>MS4-32SOLVENT</b>		-	
			
<b>90° Bend Multifit x plain end*</b>			
<b>MS4L</b>	<b>MT4L</b>	<b>MZ4L</b>	
			
<b>135° Bend</b>			
<b>MS20</b>	<b>MT20</b>	<b>MZ20</b>	
			
<b>135° Bend Multifit x plain end*</b>			
<b>MS20L</b>	<b>MT20L</b>	<b>MZ20L</b>	
			
<b>Straight Connector</b>			
<b>S28M</b>	<b>T28M</b>	<b>Z28M</b>	
			
<b>Reducing Connector 1½" x 1¼"</b>			
-	<b>ST28M</b>	-	

	1¼" Code	1½" Code	2" Code
			
<b>Straight Connector Multifit x European pipe size</b>			
x 32mm	x 40mm	x 50mm	
<b>S28L-ISO</b>	<b>T28L-ISO</b>	<b>Z28L-ISO</b>	
x 40mm	-	-	
<b>ST28L-ISO</b>	-	-	
			
<b>Adjustable Straight Connector</b>			
<b>MS18E</b>	<b>MT18E</b>	<b>MZ18E</b>	
			
<b>Straight Connector Multifit x plain end*</b>			
<b>MS18L</b>	<b>MT18L</b>	-	
			
<b>Swept Tee</b>			
<b>V8M</b>	<b>V1M</b>	<b>V15M</b>	
			
<b>1½" Equal Slip Tee with universal compression connections</b>			
-	<b>V1MX</b>	-	
			
<b>Reducer for Fittings*</b>			
1½" x 1¼"	<b>T12M</b>	-	
2" x 1¼"	-	<b>ZS26L</b>	
2" x 1½"	-	<b>ZT26L</b>	
2" x 19/23mm	-	<b>TUN-2</b>	

- Fittings marked\* have plain ends which are designed to fit into other fittings or traps with Multifit or universal compression connection

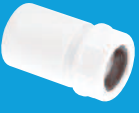
	1¼"	1½"	2"
	Code	Code	Code
	<b>Reducer in ABS*</b> 1¼" plain tail to BS EN 1329-1:2000 x 19/23mm universal compression connection		
	<b>R16</b>	-	-

	<b>Reducer in ABS*</b> 1½" plain tail to BS EN 1329-1:2000 x 19/23mm universal compression connection		
	-	<b>R17</b>	-

	<b>Rubber Reducer</b> 1¼" x 1"/28mm		
	<b>T12R</b>	-	-

	<b>Straight Connector</b> Multifit x BSP female thread		
	<b>S29</b>	<b>T29</b>	<b>Z29</b>

	<b>Straight Connector</b> Multifit x BSP coupling nut		
	<b>S29-LN</b>	<b>T29-LN</b>	-

	<b>90° Bend</b> Multifit x BSP coupling nut		
	<b>S5M</b>	<b>T5M</b>	<b>Z5M</b>

	<b>95° Bend</b> Multifit x BSP coupling nut		
	<b>S5M-A</b>	<b>T5M-A</b>	-

	<b>135° Bend</b> universal compression connection x BSP coupling nut		
	-	<b>ST90-OUT</b>	-

	1¼"	1½"	2"
	Code	Code	Code
	<b>Straight Connector</b> BSP male thread x universal compression connection		
	<b>S31M</b>	<b>T31M</b>	-

	<b>Multifit Tank Connector</b>		
	<b>S11M</b>	<b>T11M</b>	<b>Z11M</b>

	<b>Multifit Bent Tank Connector</b>		
	<b>MS4-TANK</b>	<b>MT4-TANK</b>	<b>MZ4-TANK</b>

	<b>Blanking Cap</b> for Multifit fittings		
	<b>S23M</b>	<b>T23M</b>	<b>Z23M</b>

	<b>Blanking Cap</b> for waste pipe with universal compression connection		
	<b>S23U</b>	<b>T23U</b>	<b>Z23U</b>

	<b>2" Caulking Ferrule</b>		
	<b>S21A</b>	<b>T21A</b>	<b>Z21A</b>

	<b>In-Line Connector with Filter - Top Access</b> universal compression connection x ABS plain spigot BS EN 1329-1:2000		
	-	<b>T28M-FIL</b>	-

	<b>Loose Nut</b>		
	<b>S8M</b>	<b>T8M</b>	<b>Z8M</b>

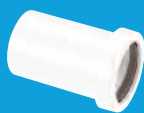
	<b>Straight Connector</b> pushfit to solvent weld		
	<b>S18-ABS</b>	<b>T18-ABS</b>	



# Flexible Waste Fittings and Non-Return Valves

**Flexible Connector** offers maximum flexibility when conventional fittings cannot be used

- Maximum effective length 18"
- PVC Plain spigot to suit Multifit and universal compression outlet traps or waste fittings. Also suitable for solvent welding to pipe BS EN 1329-1:2000
- Universal compression outlet connection



1¼" Code	1½" Code	2" Code
<b>FLEXCON1</b>	<b>FLEXCON2</b>	-

**Flexible Connector** offers maximum flexibility when conventional fittings cannot be used

- Maximum effective length 18"
- Universal compression connection x 1½" BSP coupling nut

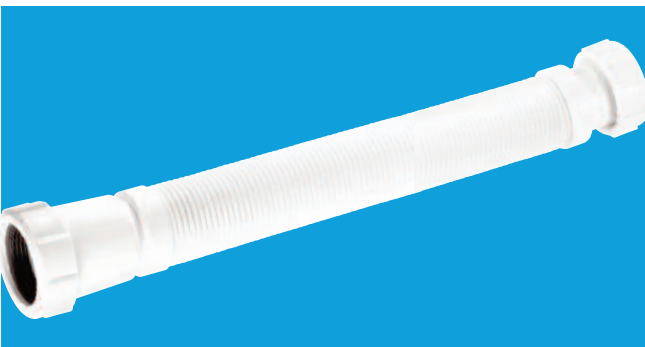

-	<b>FLEXCON2-LN</b>	-
---	--------------------	---

## Flexible Fittings

- These fittings offer complete flexibility for any required angle or offset

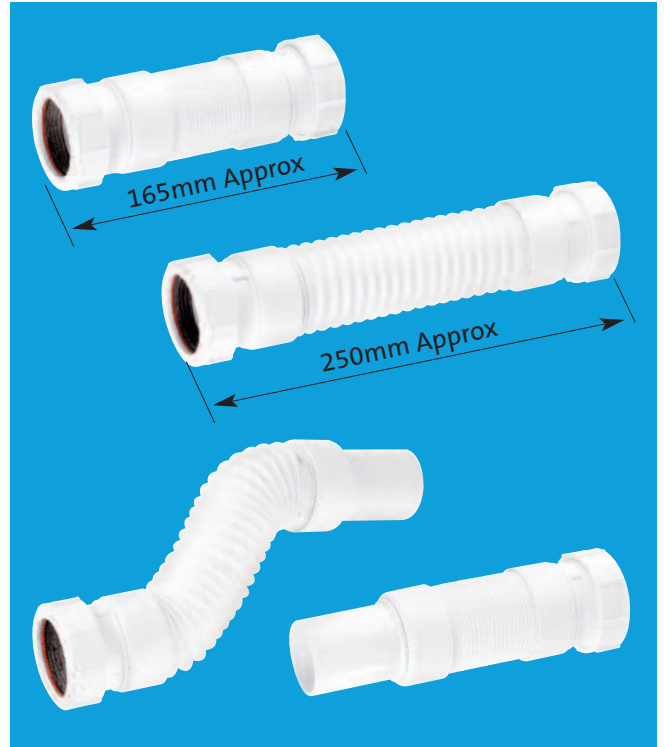

1¼" Code	1½" Code	2" Code
----------	----------	---------

### Universal Compression Connection x Universal Compression Connection

<b>FLEXCON3</b>	<b>FLEXCON4</b>	<b>FLEXCON7</b>
-----------------	-----------------	-----------------

### Universal Compression Connection x PVC Plain Spigot suitable for solvent welding to pipe BS EN 1329-1:2000

<b>FLEXCON5</b>	<b>FLEXCON6</b>	<b>FLEXCON8</b>
-----------------	-----------------	-----------------

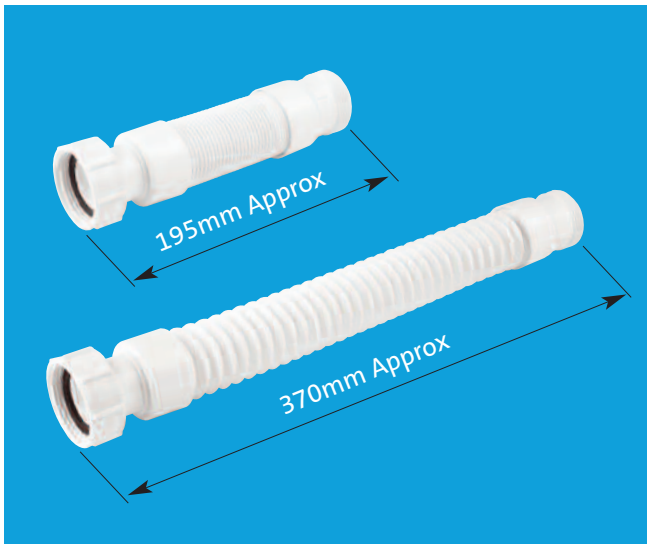

1 1/4" BSP coupling nut x 1 1/4" BSP male thread

Code **FLEX-JKS**

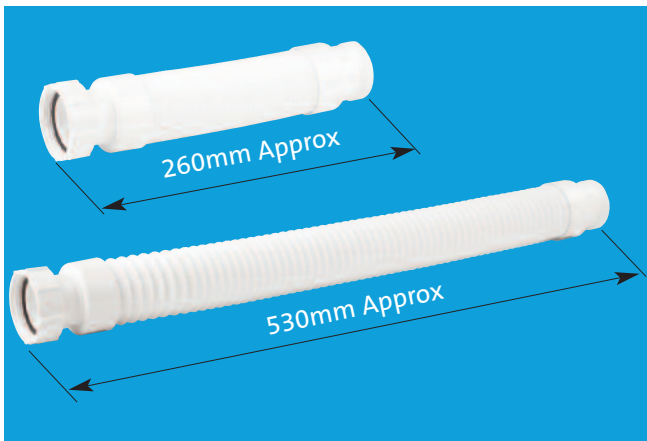

1 1/2" BSP coupling nut x 1 1/2" BSP male thread

Code **FLEXCON9**

**FLEXCON9**



**Non-Return Valves**



1 1/4" Code	1 1/2" Code	2" Code
<b>In-Line Non-Return Valve</b> with 1 1/2" universal compression connections and top access for cleaning		
<b>S28M-NRV</b>	<b>T28M-NRV</b>	-



<b>In-Line Non-Return Valve</b> with 2" universal compression connections and top access for cleaning		
-	-	<b>Z28M-NRV</b>











<b>In-Line Non-Return Valve</b> with 2" BS EN 1329-1:2000 solvent weld connections and top access for cleaning		
-	-	<b>Z28M-NRV5</b>



■ The above Non-Return Valves are designed to prevent a back flow of water and must be installed in a horizontal position. They must only be used when there is no alternative and on the basis that they are cleaned regularly

# Sundry Fittings









## Sundry Fittings

	1¼"	1½"	2"
	Code	Code	Code
<b>90° Bend</b> with BSP male thread x BSP coupling nut			
<b>S1</b>	<b>T1</b>	<b>Z1</b>	
	<b>BSP Nut</b> ordinary		
	<b>S8A</b>	<b>T8A</b>	<b>Z8A</b>
	<b>BSP Nut</b> compression		
	<b>S8B</b>	<b>T8B</b>	<b>Z8B</b>
	<b>Compression Ring for Imperial Copper</b>		
	<b>S13-ISON</b>	<b>T13-ISON</b>	-
	<b>BSP Coupling</b> to BS EN 1329-1:2000 ABS or PVC pipe, must be solvent welded		
	<b>S25</b>	<b>T25</b>	-
	<b>Trap Inlet Reducer</b>		
	1¼" x 1"		
	<b>S16</b>	-	-
	1½" x 1¼"	<b>T16</b>	-
	<b>Blank Cap</b> with nut for BSP threads		
	<b>S23</b>	<b>T23</b>	<b>Z23</b>
	<b>7" Extension Piece</b> effective length 5". Available longer or shorter on application		
	<b>S22L</b>	<b>T22L</b>	-

## BSP Female x BSP Male Couplings

	1¼"	1½"
	Code	Code
<b>BSP Coupling</b>		
1" length	<b>S12A-1</b>	<b>T12A-1</b>
2" length	<b>S12A-2</b>	<b>T12A-2</b>
3" length	<b>S12A-3</b>	<b>T12A-3</b>
	<b>BSP Coupling</b> flush spigot European to UK waste adaptor	
	<b>S12A-F</b>	<b>T12A-F</b>

## BSP Female x BSP Male Couplings

	1¼"	1½"	
	Code	Code	
<b>BSP Coupling</b>			
1¼" x 1"	<b>S12C</b>	-	
1" x ¾"	<b>S12D</b>	-	
	<b>BSP Coupling</b> waste outlet reducer		
	1½" x 1¼"	-	<b>T12</b>
	<b>BSP Coupling</b>		
	1¾" x 1½"	-	<b>T12B</b>
	2" x 1½"	-	<b>T12C</b>
	2" x 1¼"	-	<b>T12D</b>
	1½" x 1"	-	<b>T12H</b>
	<b>BSP Coupling</b>		
	1½" x 2"	-	<b>T12E</b>
	1½" x 1¾"	-	<b>T12F</b>
	<b>¾" Female Blank Cap</b> for blanking off appliance valves with ¾" male thread		
	Code	<b>NUT-WMVALVE</b>	
	<b>1" Female Blank Cap</b> for traps and fittings with 1" male thread		
	Code	<b>NUT-BLANK-WH</b>	
	<b>1½" Pipe Clip</b> for floor mounted discharge pipe installations		
	Code	<b>T30-CLAMP</b>	
	<b>Stackable Gradient Spacer</b> for use with T30-CLAMP allowing for a fall of varying degrees		
	Code	<b>T30-SPACER</b>	



	1¼" Code	1½" Code	2" Code
<b>HDPE White Pipe</b> 3m lengths			
	<b>HD1-3M</b>	<b>HD2-3M</b>	<b>HD3-3M</b>

	<b>Pipe Clip</b>		
	<b>S30</b>	<b>T30</b>	<b>Z30</b>

	<b>90° Bend</b>		
	<b>S4L</b>	<b>T4L</b>	<b>Z4L</b>

	<b>Straight Connector</b>		
	<b>S18L</b>	<b>T18L</b>	<b>Z18L</b>

	<b>Straight Connector</b> Multifit x Surefit		
	<b>S28L</b>	<b>T28L</b>	<b>Z28L</b>

	<b>Reducing Connector</b> 1½" x 1¼"		
	-	<b>T12L</b>	-

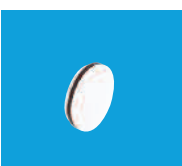
	<b>Blank Cap</b> without nut		
	<b>S23L</b>	<b>T23L</b>	<b>Z23L</b>

	<b>Reducer for Fittings</b>		
	2"-1¼"	1½"-1¼"	2"-1½"
	<b>S26L</b>	<b>T12S</b>	<b>T26L</b>

	1¼" Code	1½" Code
<b>Swept Tee</b>		
	<b>V8L</b>	<b>V1L</b>

	<b>Swept Tee</b>		
	1½" x 1½" x 1¼"	-	<b>V21L</b>

	<b>Swept Tee</b> Surefit x 19mm pushfit branch		
	1½" x 1½" x ¾"	-	<b>V23L</b>
	1¼" x 1¼" x ¾"	<b>V24L</b>	-

	1¼" Code	1½" Code	2" Code
<b>Straight Connector</b> to soil pipe boss BS EN 1451-1:2000 size*			
	<b>S18M</b>	<b>T18M</b>	<b>Z18M</b>







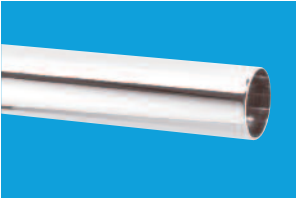
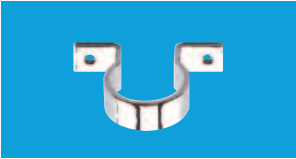

	<b>Wall Flange</b> for HDPE pipe		
	<b>S17</b>	<b>T17</b>	-

- \*BS 5254 size - if connecting to boss size BS 5255 add 5255 to code e.g. S18M 5255
- Surefit waste fittings only suitable for M<sup>C</sup>Alpine HDPE waste pipe

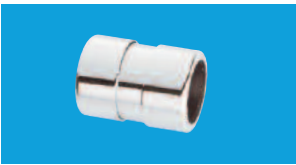

# Chrome Plated Brass Waste Pipe and Fittings

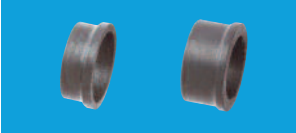
Chrome Plated Brass Waste Pipe and Fittings

	European pipe size	1¼" UK pipe size	1½" UK pipe size
	<b>1m length of CP Brass Pipe</b>		
	<b>PIPE32-1000-CB</b>	<b>PIPE35-1000-CB</b>	<b>PIPE42-1000-CB</b>
	<b>CP Pipe Clip</b>		
	<b>S32-CP</b>	<b>S35-CP</b>	<b>T42-CP</b>
	<b>90° Compression Bend</b>		
	<b>32A-CB</b>	<b>35A-CB</b>	<b>42A-CB</b>
	<b>135° Compression Bend</b>		
	-	<b>35B-CB</b>	<b>42B-CB</b>
	<b>Compression Tee</b>		
	-	-	<b>42E-CB</b>
	<b>Blanking Cap for above fitting</b>		
	-	-	<b>40K-CB</b>
	<b>Compression Straight Connector</b>		
	<b>32G-CB</b>	<b>35G-CB</b>	<b>42G-CB</b>
	<b>Wall Flange</b>		
	<b>WALLFLANGE-CP32</b>	<b>WALLFLANGE-CP35</b>	<b>WALLFLANGE-CP42</b>
	<b>Synthetic Rubber Seal Reducers for above fittings</b>		
		<b>R/SEAL-35X32</b>	<b>R/SEAL-42X32</b> <b>R/SEAL-42X35</b>
	<b>ABS Solvent Weld Adaptor to convert above fittings to BS EN 1329-1:2000 plastic solvent weld waste pipe</b>		
	<b>ABSCON-32X1.25</b>	<b>ABSCON-35X1.25</b>	<b>ABSCON-42X1.5</b>

NOTE: European sizes only



**90° Bend** 32/35mm compression CP brass x 1 1/4" ABS solvent weld

Code **ABS32/35A-CB**

**90° Bend** 42/43mm compression CP brass x 1 1/2" ABS solvent weld

Code **ABS42/43A-CB**



**Straight Connector** 32/35mm compression CP brass x 1 1/4" ABS solvent weld

Code **ABS32/35G-CB**

**Straight Connector** 42/43mm compression CP brass x 1 1/2" ABS solvent weld

Code **ABS42/43G-CB**



**Elongated 90° Bend** 32/35mm compression CP brass x 1 1/4" ABS solvent weld

Code **ABS32/35A-CB-L**



**90° Bend** 32mm European pipe size ring seal pushfit x 1 1/4" Multifit

Code **MS4-32MM**



**90° Bend** 32mm European pipe size ring seal pushfit x 1 1/4" ABS solvent weld

Code **MS4-32SOLVENT**

- For Multifit fittings suitable for use with 35mm and 42mm external diameter pipe see pages 54 and 55
- For Chrome Plated Traps see pages 7 and 22

*ABS32/35G-CB can be used in conjunction with WALLFLANGE-CP42. As illustrated below*



# Drain Connectors and Blanking Off Caps

- Manufactured in polypropylene
- Finned seal spigot for internal connection to cast iron, plastic or clay 4"/110mm pipe
- Ideal for low level connections
- Reducers allow for connection to BS EN 1451-1:2000 and BS EN 1329-1:2000 pipe



**4"/110mm x 4"/110mm Connector** with 'O' seal socket to fit 4"/110mm pipe to BS 4514

Code (Black)	<b>DC1-BL</b>
Code (Grey)	<b>DC1-GR</b>

With 14mm offset

Code (Black)	<b>DC1BL-OS</b>
Code (Grey)	<b>DC1GR-OS</b>

## Drain Connector with Boss



**4"/110mm x 4"/110mm Connector** with 'O' seal socket to fit 4"/110mm pipe to BS 4514 and 1½" universal pipe boss including blanking cap. **Should only be fitted on ground floor due to a reduction in the internal outlet diameter of the boss pipe connector**

Code (Black)	<b>DC1-BL-BO</b>
Code (Grey)	<b>DC1-GR-BO</b>

## Drain Connector 90° Bend



**90° Bend 4"/110mm x 4"/110mm** with 'O' seal socket to fit 4"/110mm pipe to BS 4514

Code (Black)	<b>DC90-BL</b>
Code (Grey)	<b>DC90-GR</b>

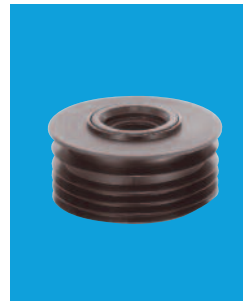

**4"/110mm Reducer Connector** with sealing ring to fit to plastic waste pipe

	Code
1¼" and 1½"	<b>DC2-BL</b>
2"	<b>DC3-BL</b>

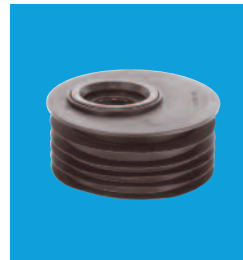

**4"/110mm Reducer Connector** with offset sealing ring to fit to plastic waste pipe

1¼" and 1½"	<b>DC2BL-OS</b>
2"	<b>DC3BL-OS</b>



**4"/110mm Blanking Cap** suitable for sealing cast iron, plastic or clay 4"/110mm pipe

Code	<b>DC4-BL</b>
------	---------------

## Temporary Blanking Off Caps



**Synthetic Rubber Cap** for sealing 110mm pipe

Code	<b>CAP100</b>
------	---------------



1¼"	1½"	2"
Code	Code	Code

**Synthetic Rubber Cap** for waste pipe

<b>S23MR</b>	<b>T23MR</b>	<b>Z23MR</b>
--------------	--------------	--------------

- Suitable for waste water and condensate discharge
- Simple dry fixing mechanical connection

### Mechanical Soil Pipe Boss Connectors to suit 57mm hole saw size



- Universal compression connection for pushfit or solvent weld waste pipe
- All boss connectors supplied with fixing tool

### Two-Piece Cast Iron Soil Pipe Boss Connector to suit 22mm drill size for CONDENSATE DISCHARGE ONLY



4"/100mm x 1¼" pipe  
Code **BOSS110CAST-BL**

4"/100mm x 1½" pipe  
Code **BOSS110TCAST-BL**

3½"/90mm x 1¼" pipe  
Code **BOSS90CAST-BL**

3½"/90mm x 1½" pipe  
Code **BOSS90TCAST-BL**

3"/82mm x 1¼" pipe  
Code **BOSS82CAST-BL**

3"/82mm x 1½" pipe  
Code **BOSS82TCAST-BL**



4"/110mm x 1¼" pipe  
Code **BOSSCONN110-BL**

4"/110mm x 1½" pipe  
Code **BOSSCONN110T-BL**

4"/110mm x 2" pipe  
Code **BOSSCONN110Z-BL**

3"/82mm x 1¼" pipe  
Code **BOSSCONN82-BL**

3"/82mm x 1½" pipe  
Code **BOSSCONN82T-BL**

3"/82mm x 2" pipe  
Code **BOSSCONN82Z-BL**



4"/110mm x 1¼" pipe  
Code **BOSSCONN110-GR**

4"/110mm x 1½" pipe  
Code **BOSSCONN110T-GR**

4"/110mm x 2" pipe  
Code **BOSSCONN110Z-GR**

3"/82mm x 1¼" pipe  
Code **BOSSCONN82-GR**

3"/82mm x 1½" pipe  
Code **BOSSCONN82T-GR**

3"/82mm x 2" pipe  
Code **BOSSCONN82Z-GR**

### Mechanical Soil and Rainwater Pipe Boss Connectors



**Mechanical Soil and Rainwater Pipe Boss Connector** for 1¼" pipe

Code **BOSSCONN1.25BL**

Code **BOSSCONN1.25GR**



**Reducer in ABS** 1¼" plain tail x 19/23mm universal compression connection

Code **R16-BL**

Code **R16-GR**



**Mechanical Soil and Rainwater Pipe Boss Connector** for 19/23mm pipe

Code **BOSSCONN-22MM**

### Threaded Boss Connectors



**Straight Connector** 2" BSP male thread x Multifit

2" BSP x 1¼" Multifit **ZS31M**

2" BSP x 1½" Multifit **ZT31M**

2" BSP x 2" Multifit **Z31M**



### General

- MacFlash Aluminium Roof Flashing offers an alternative to traditional lead roof slates
- The aluminium flashing is manufactured from high grade aluminium and the collar from synthetic rubber, both to British Standards. The collar is die-formed to the aluminium flashing

### Advantages

- MacFlash is quickly and easily installed and offers cost savings in material and labour
- MacFlash is suitable for flat roofs and for roof pitches up to 45°
- MacFlash has special corrugations that can be easily dressed to form a seal
- MacFlash can be used with flue pipes from condensing boilers

**Nominal Pipe Size** 4"/110mm pipe  
**Base Measurements** 18" x 18"

Code **RS1**

**Nominal Pipe Size** 3"/75mm pipe  
**Base Measurements** 18" x 18"

Code **RS4**

**Nominal Pipe Size** 4"/110mm pipe  
**Base Measurements** 18" x 24"

Code **RS2**

**Nominal Pipe Size** 2"/50mm pipe  
**Base Measurements** 18" x 18"

Code **RS7**













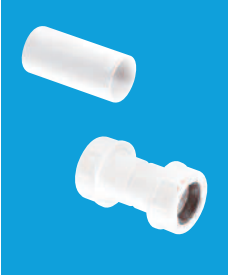



**Nominal Pipe Size** 4"/110mm pipe  
**Base Measurements** 24" x 24"

Code **RS3**



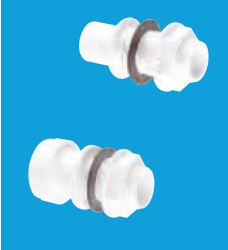









## 3/4" Overflow Pipe, Pushfit and Universal Fittings

	Code <b>HDPE White Overflow Pipe</b> 3/4" x 3m lengths <b>R-3M</b>		Code <b>Blanking Cap</b> for overflow pipe with universal compression connection <b>R23U</b>
	<b>Straight Connectors</b> 3/4" pushfit <b>R1</b> 19/23mm universal compression connections <b>R1M</b>		<b>Bent Tank Connectors</b> 3/4" pushfit <b>R5</b> 19/23mm universal compression connections <b>R5M</b>
	<b>Straight Connector</b> with universal compression connections for 19/23mm rigid pipe and 25mm flexible pipe <b>R1M-CO</b>		<b>Straight Female Coupling</b> with fixed nut <b>R6</b>
	<b>90° Bends</b> 3/4" pushfit <b>R2</b> 19/23mm universal compression connections <b>R2M</b>		<b>Straight Female Coupling</b> with loose nut <b>R6A</b>
	<b>135° Bends</b> 3/4" pushfit <b>R2A</b> 19/23mm universal compression connections <b>R2AM</b>		<b>Straight Female Coupling</b> with fixed nut for converting male BSP outlets to pushfit fittings <b>R7</b>
	<b>Tees</b> 3/4" pushfit <b>R3</b> 19/23mm universal compression connections <b>R3M</b>		<b>90° Female Coupling</b> with loose nut <b>R8A</b>
	<b>Straight Tank Connectors</b> 3/4" pushfit <b>R4</b> 19/23mm universal compression connections <b>R4M</b>		<b>ABS Adaptor</b> to convert 19mm connections up to 23mm OD pipe <b>R13</b>
			<b>Reducer in ABS</b> 1 1/4" plain tail to BS EN 1329-1:2000 x 19/23mm universal compression connection <b>R16</b>
			<b>Reducer in ABS</b> 1 1/2" plain tail to BS EN 1329-1:2000 x 19/23mm universal compression connection <b>R17</b>



	1 1/4" Code	1 1/2" Code
	<b>HDPE White Pipe</b> 3m lengths	
	<b>HD1-3M</b>	<b>HD2-3M</b>
	<b>Pipe Clip</b>	
	<b>S30</b>	<b>T30</b>
	<b>90° Bend</b>	
	<b>S4A</b>	<b>T4A</b>
	<b>90° Knuckle Bend</b>	
	<b>S4E</b>	<b>T4E</b>
	<b>90° Bend x BSP coupling nut</b>	
	<b>S5</b>	<b>T5</b>
	<b>Straight Connector</b>	
	<b>S18</b>	<b>T18</b>
	<b>Adaptor</b>	
	<b>S7</b>	<b>T7</b>
	<b>BSP Nut ordinary</b>	
	<b>S8A</b>	<b>T8A</b>
	<b>BSP Screwed Adaptor</b>	
	<b>S9</b>	<b>T9</b>

**Standing Waste Backnut Model**



All standing wastes are supplied with backnut and washers  
**Standard length of stand pipe 18"**

When ordering state:  
 (1) Code  
 (2) Height required if not 18"

1 1/4" x 70mm flange x 3 1/2" tail  
 Code **SWL-18**

1 1/2" x 70mm flange x 3 1/2" tail  
 Code **TWL-18**

1 1/4" x 70mm flange x 1 1/2" tail  
 Code **SWS-18**

1 1/2" x 70mm flange x 1 1/2" tail  
 Code **TWS-18**

**Tank Overflow**



**Unslotted Waste without Grid**

1 1/4" x 70mm flange x 3 1/2" tail  
 Code **W10**

1 1/2" x 70mm flange x 3 1/2" tail  
 Code **W20**

1 1/4" x 70mm flange x 1 1/2" tail  
 Code **W11**

1 1/2" x 70mm flange x 1 1/2" tail  
 Code **W21**



## Water Storage Cistern Fittings (Ex Bye-law 30 Fittings)



3/4" Code	1" Code	1¼" Code	1½" Code	2" Code
--------------	------------	-------------	-------------	------------

**Complete Screened Tank Overflow Connector** with quick release filter - standard model

<b>R30</b>	<b>H28</b>	<b>R40</b>	<b>R45</b>	-
------------	------------	------------	------------	---



**Complete Screened Tank Overflow Connector** with quick release filter - extended model

<b>R30E</b>	-	<b>R40E</b>	<b>R45E</b>	-
-------------	---	-------------	-------------	---



**Screened Tank Breather**

<b>R31</b>	-	<b>SWLFBR</b>	<b>TWLFBR</b>	<b>ZWLFBR</b>
------------	---	---------------	---------------	---------------



**Screened Breather/Filter** with universal compression connection to pipe

<b>R32</b>	-	-	-	-
------------	---	---	---	---



**Tank Lid Adaptor** for expansion pipe

<b>R33</b>	-	-	-	-
------------	---	---	---	---



**Tank Connector**

<b>R4M</b>	<b>H11M</b>	<b>S11M</b>	<b>T11M</b>	<b>Z11M</b>
------------	-------------	-------------	-------------	-------------



3/4" Code	1" Code	1 1/4" Code	1 1/2" Code	2" Code
--------------	------------	----------------	----------------	------------

**Complete 3/4" BL30 Kit** comprising R30, R31, R33

<b>BL30-3/4</b>	-	-	-	-
-----------------	---	---	---	---



**Screened Breather/Filter/Frost Cover** with universal compression connection to pipe

-	-	<b>SWLFCV</b>	<b>TWLFCV</b>	-
---	---	---------------	---------------	---



**In-Line Screened/Filter Pipe Coupling**

<b>RWILF</b>	<b>HWILF</b>	<b>SWILF</b>	<b>TWILF</b>	<b>ZWILF</b>
--------------	--------------	--------------	--------------	--------------



**Frost Protection Dip Tube Bend**  
Connect pipe to provide length of dip tube required

-	-	<b>S5</b>	<b>T5</b>	-
---	---	-----------	-----------	---



**90° Multifit x Plain End**

-	-	<b>MS4L</b>	<b>MT4L</b>	<b>MZ4L</b>
---	---	-------------	-------------	-------------



**90° Multifit Bend**

-	-	<b>MS4</b>	<b>MT4</b>	<b>MZ4</b>
---	---	------------	------------	------------

## Tundishes and Non-Return Valves

### Tundishes



**Tundish** with 3/4" pushfit outlet

Code

**TUN-1**



**Tundish** with 19/23mm universal compression outlet

**TUN-2**



**One-Piece Side Inlet Tundish** with 19/23mm universal compression outlet

**TUN-3**



**One-Piece Tundish** with 3/4" loose nut inlet x 19/23mm universal compression outlet

**TUN-4**



**One-Piece Tundish** with 19/23mm universal compression inlet x 1 1/4" universal compression outlet

**TUN-6**

### Non-Return Valves for WC Overflow



**Tunvalve (Clear)** with 3/4" female threaded inlet connection to WC overflow outlet x 19/23mm universal compression outlet

Code

**TUNVALVE**



**Tunvalve Straight Through (Clear)** with 19/23mm universal compression connections

Code

**TUN5-CL**

### In-Line Non-Return Valves



**Non-Return Valve** with 19/23mm universal compression connections

Code

**R28-NRV**



**90° Elbow with integral Non-Return Valve.** Plain tail inlet x 19/23mm universal compression outlet

Code

**R29-NRV**



**Convalve Non-Return Valve** with 1 1/4" universal compression connections

Code

**CONVALVE-125**



**Convalve Non-Return Valve** with 1 1/4" plain tail x 1 1/4" universal compression outlet

Code

**CONVALVE-125P**

### WC Overflow Kits with Tundish - Overflow into Flush Pipe

- Before installation relaxation of Bye-law 84 is required by local water authority



**WC Overflow Kit** comprises TUN-2, V33T, 90° pushfit elbow and two 3/4" x 12" lengths of overflow pipe †

Code **TUNKIT-1**

**WC Overflow Kit** comprises TUN-3, V33T, 90° pushfit elbow and two 3/4" x 12" lengths of overflow pipe †

Code **TUNKIT-3**

† Not suitable for use with high level cisterns as installation into external flush pipe would cause malfunction of the syphonic flushing action

### Tee Pieces



**Tee Piece** 1 1/2" BSP nut x 1 1/4" universal compression connection x 19/23mm universal compression connection †

Code **V33T**



**Tee Piece** with universal compression connection to flush pipe at both ends x 19/23mm universal compression connection †

Code **V33T-FP**



**Tee Piece** 1 1/2" BSP nut x 1 1/2" BSP thread x 19/23mm universal compression connection †

Code **V33S-22**

† Not suitable for use with high level cisterns as installation into external flush pipe would cause malfunction of the syphonic flushing action



Code **TUN-6**



Code **TUNVALVE**





# WC Connectors

## MACFIT, Flexible and Rigid

SECTION

5



WC Connectors

# WC Connectors

## WC Connectors General

- M<sup>c</sup>Alpine is the only European manufacturer to offer EVA (ethylene vinyl acetate), rigid polypropylene and flexible polypropylene WC connectors
- All outlets fit inside diameter pipe sizes as follows:
  - 110mm Plain End:** Ring seal socket of 110mm soil or underground pipe fittings
  - 4"/110mm:** PVC-U and cast iron
  - 3½"/90mm:** Cast iron
  - 3"/75mm:** PVC-U and cast iron
- Fixing instructions and dimensional leaflet for all WC connectors available on request

## MACFIT

- MACFIT WC connectors are manufactured in EVA with synthetic rubber and moulded finned seals
- MACFIT incorporates a new 'lock ring' inlet seal (patent pending) to give a superior, tighter connection to the WC pan outlet
- European Patent No. 1655528

MACFIT WC Connectors

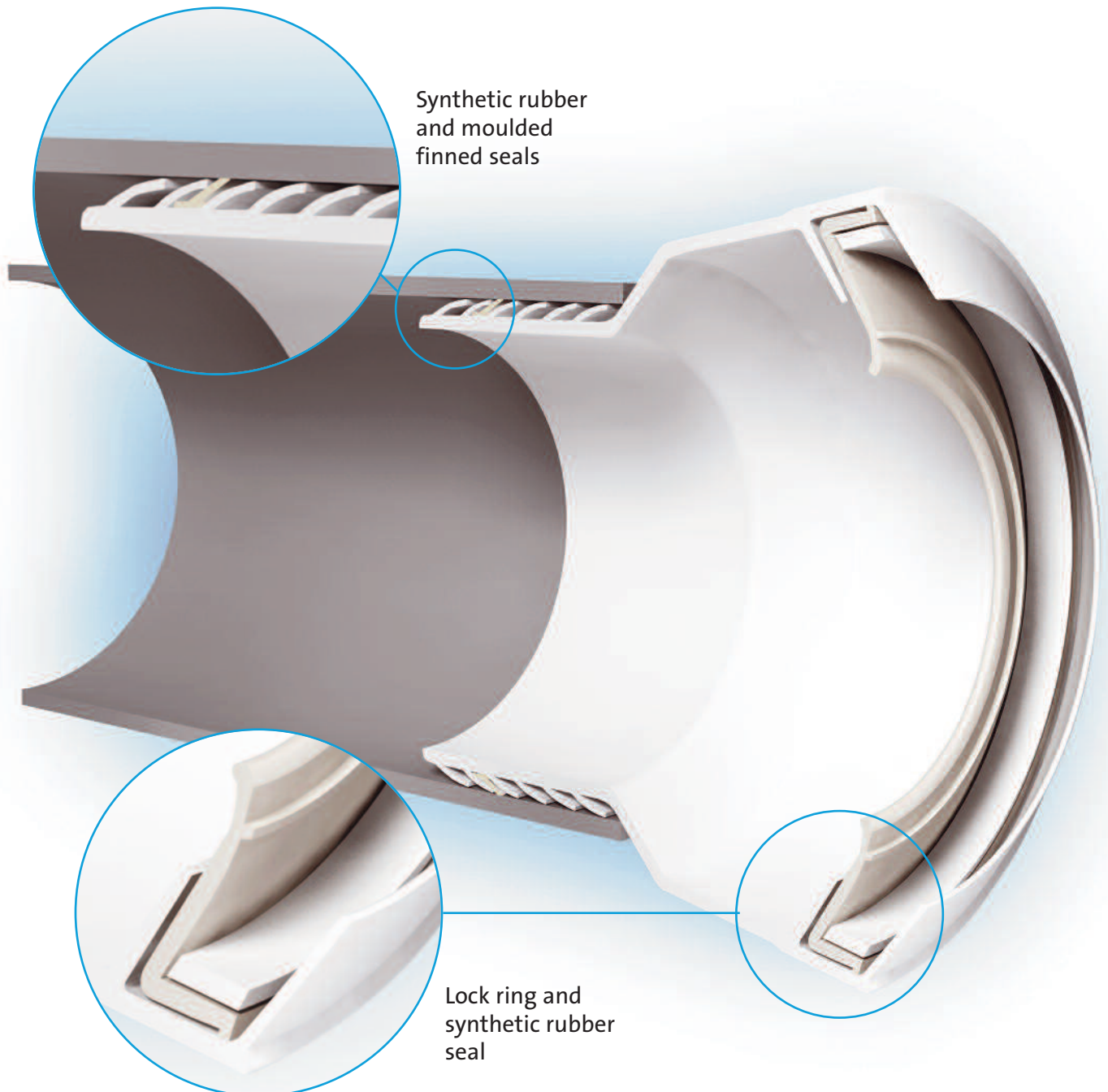





Straight  
97-107mm Inlet  
4"/110mm Outlet

Code **MAC-1**



Straight  
97-107mm Inlet  
3 1/2"/90mm Outlet

Code **MAC-3**



Straight  
97-107mm Inlet  
3"/75mm Outlet

Code **MAC-3C**



20mm Offset  
97-107mm Inlet  
4"/110mm Outlet

Code **MAC-4**



40mm Offset  
97-107mm Inlet  
4"/110mm Outlet

Code **MAC-4A**



14° Angle  
97-107mm Inlet  
4"/110mm Outlet

Code **MAC-7A**



90° Bend  
97-107mm Inlet  
4"/110mm Outlet

Code **MAC-8**



90° Bend (Long)  
97-107mm Inlet  
4"/110mm Outlet

Code **MAC-8L**



Straight Extension  
Adjustable Length  
4"/110mm Outlet

Code **MAC-EXTA**



Straight Extension  
Adjustable Length  
3 1/2"/90mm Outlet

Code **MAC-EXTB**



Straight Extension  
Adjustable Length  
3"/75mm Outlet

Code **MAC-EXTC**



Linking Connector  
Adjustable Length  
(Polypropylene)

Code **MACLINK**

### Short Straight Connector

- Connector can be used where the soil pipe has already been installed with only the final fixing of the WC pan to be connected
- Soft synthetic rubber inlet connection secured by a worm drive hose clip provides a secure and reliable connection to the WC pan spigot



Overall length of  
connector 88mm  
97-107mm Inlet -  
4"/110mm Outlet

Code **MAC-1-BTW**



# Flexible WC Connectors

- There is no British Standard for flexible WC connectors but M<sup>C</sup>Alpine connectors comply to German Standard DIN 1389:2000-05 for flexible WC connectors
- Tested by German Testing House LGA, certificate number 572125072a and other testing houses. Tests prove conclusively that there is no build-up of sediment and the product is perfectly fit for purpose

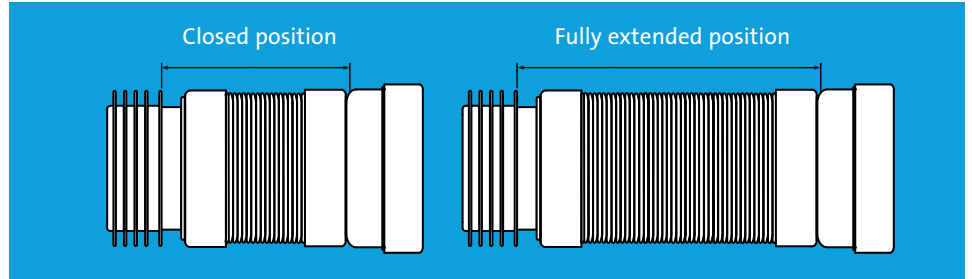

## 97-107mm Inlet 4"/110mm Outlet



Closed 170mm	>	Extended 410mm	Closed 140mm	>	Extended 290mm	Closed 100mm	>	Extended 160mm
<b>WC-F26R</b>			<b>WC-F23R</b>			<b>WC-F18R</b>		

## 97-107mm Inlet 4"/110mm Outlet 1¼" Universal Vent Boss



180mm	>	380mm	150mm	>	280mm			
<b>WC-F26RV</b>			<b>WC-F23RV</b>			-		

## 97-107mm Inlet 3½"/90mm Outlet



170mm	>	410mm	140mm	>	290mm	100mm	>	160mm
<b>WC-F26S</b>			<b>WC-F23S</b>			<b>WC-F18S</b>		

## 97-107mm Inlet 3½"/90mm Outlet 1¼" Universal Vent Boss



180mm	>	380mm	150mm	>	280mm			
<b>WC-F26SV</b>			<b>WC-F23SV</b>			-		

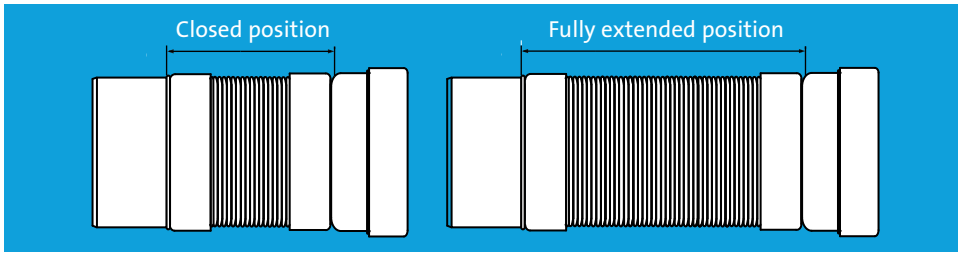

**97-107mm Inlet 110mm Plain End Outlet**

Closed 160mm > Extended 380mm      Closed 130mm > Extended 260mm

**WC-F26P**

**WC-F23P**

-



**97-107mm Inlet 110mm Plain End Outlet 1 1/4" Universal Vent Boss**

170mm > 380mm      140mm > 260mm

**WC-F26PV**

**WC-F23PV**

-

**90° Flexible WC Connectors**



**97-107mm Inlet 4"/110mm Outlet**

Closed 190mm > Extended 270mm

Code **WC-CON8F18**



**97-107mm Inlet 4"/110mm Outlet**

220mm > 400mm

Code **WC-CON8F**



**97-107mm Inlet 4"/110mm Outlet 1 1/4" Universal Vent Boss**

220mm > 400mm

Code **WC-CON8FV**

**Flexible Extensions for WC Connectors**



**110mm Inlet 4"/110mm Outlet**

Closed 95mm > Extended 195mm

Code **EXTA-F**



**110mm Inlet 3 1/2"/90mm Outlet**

95mm > 195mm

Code **EXTB-F**

# Flexible WC Connectors for Back to Wall WC Pan

## Flexible WC Connectors for Back to Wall WC Pan

- Soft synthetic rubber inlet connection secured by a worm drive hose clip provides a secure and reliable connection to the WC pan spigot prior to the final placement against wall or furniture
- There is no British Standard for flexible WC connectors but M<sup>c</sup>Alpine WC connectors comply to German Standard DIN 1389:2000-05 for flexible WC connectors

- Tested by German Testing House LGA, certificate number 572125072a and other testing houses. Tests prove conclusively that there is no build-up of sediment and the product is perfectly fit for purpose



Closed 150mm      Extended 310mm

**97-107mm Inlet - 4"/110mm Outlet**

Code **WC-F21R**



**97-107mm Inlet - 3 1/2"/90mm Outlet**

Code **WC-F21S**

Patents pending

### 90° Short Bend in vertical position

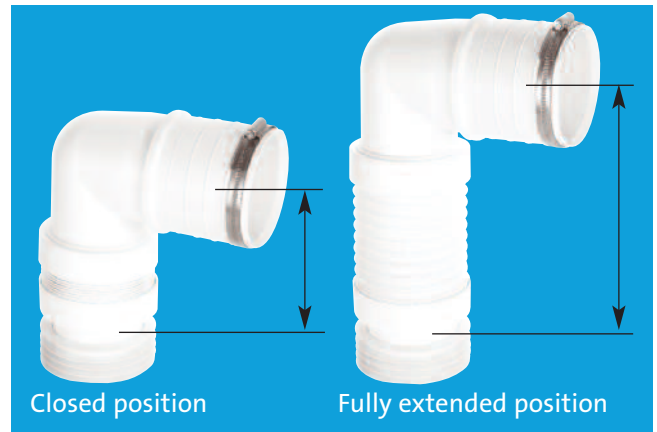

Closed 170mm

Extended 250mm

**97-107mm Inlet - 4"/110mm Outlet**

Code

**WC-CON8F18-BTW**

**97-107mm Inlet - 3 1/2"/90mm Outlet**

Code

**WC-CON8F18-S-BTW**

### 90° Long Bend in horizontal position

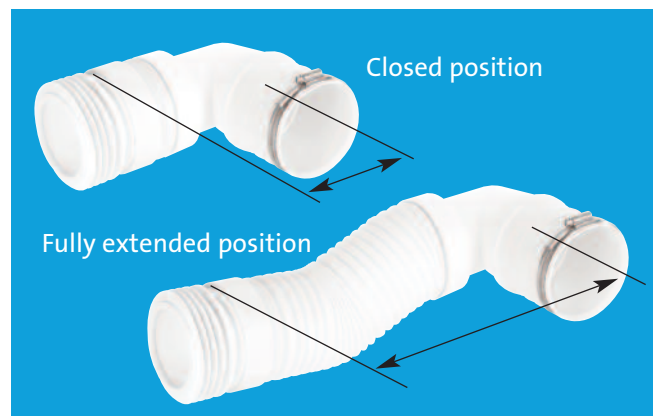

Closed 230mm

Extended 480mm

**97-107mm Inlet - 4"/110mm Outlet**

Code

**WC-CON8F-BTW**

**97-107mm Inlet - 3 1/2"/90mm Outlet**

Code

**WC-CON8F-S-BTW**

■ Dimensional leaflet available on request



**Straight**  
97-107mm Inlet  
4"/110mm Outlet

Code **WC-CON1**



**Straight with Vent Boss**  
97-107mm Inlet  
4"/110mm Outlet

Code **WC-CON1V**



**Straight Adjustable Length**  
97-107mm Inlet  
4"/110mm Outlet

Code **WC-CON2**



**Straight Adjustable Length**  
97-107mm Inlet  
3½"/90mm Outlet

Code **WC-CON2B**

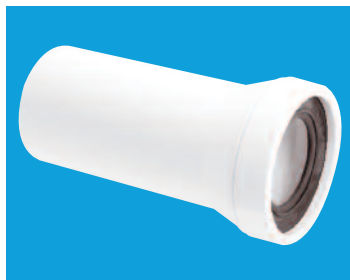

**Straight Adjustable Length**  
97-107mm Inlet  
110mm Plain End Outlet

Code **WC-CON3**



**20mm Offset Adjustable Length**  
97-107mm Inlet  
4"/110mm Outlet

Code **WC-CON4**



**40mm Offset Adjustable Length**  
97-107mm Inlet  
4"/110mm Outlet

Code **WC-CON4A**

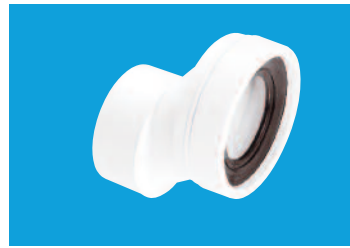

**40mm Offset Adjustable Length**  
97-107mm Inlet  
110mm Plain End Outlet

Code **WC-CON4B**



**20mm Offset Adjustable Length**  
97-107mm Inlet  
4"/110mm Outlet

Code **WC-CON5**



**20mm Offset Adjustable Length**  
97-107mm Inlet  
3½"/90mm Outlet

Code **WC-CON5B**

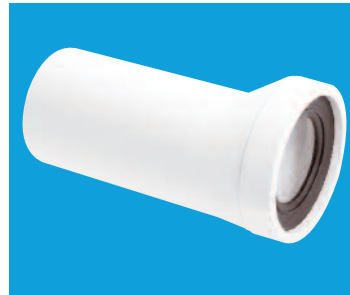

**10mm Offset Adjustable Length**  
97-107mm Inlet  
110mm Plain End Outlet

Code **WC-CON6**



**14° Angle Adjustable Length**  
97-107mm Inlet  
4"/110mm Outlet

Code **WC-CON7**



**14° Angle**  
97-107mm Inlet  
4"/110mm Outlet

Code **WC-CON7A**



**14° Angle Adjustable Length**  
97-107mm Inlet  
3½"/90mm Outlet

Code **WC-CON7B**



**45° Angle**  
97-107mm Inlet  
4"/110mm Outlet

Code **WC-CON16**



# Rigid WC Connectors



90° Bend  
Adjustable Length  
97-107mm Inlet  
4"/110mm Outlet

Code **WC-CON8**



90° Space Saving  
Bend  
Adjustable Length  
97-107mm Inlet  
4"/110mm Outlet

Code **WC-CONQ**



90° Bend  
Adjustable Length  
with Vent Boss  
97-107mm Inlet  
4"/110mm Outlet

Code **WC-CON8V**



90° Space Saving  
Bend  
Adjustable Length  
97-107mm Inlet  
110mm Plain End  
Outlet

Code **WC-CONQP**



90° Bend  
Adjustable Length  
Extended Inlet  
97-107mm Inlet  
4"/110mm Outlet

Code **WC-CON8E**

## Extension Pieces



Straight Extension  
Adjustable Length  
4"/110mm Outlet

Code **WC-EXTA**



90° Bend  
Adjustable Length  
97-107mm Inlet  
110mm Plain End  
Outlet

Code **WC-CON9**



Straight Extension  
Adjustable Length  
3½"/90mm Outlet

Code **WC-EXTB**



90° Bend  
Adjustable Length  
with Vent Boss  
97-107mm Inlet  
110mm Plain End  
Outlet

Code **WC-CON9V**



10mm Offset  
Extension  
Adjustable Length  
4"/110mm Outlet

Code **WC-EXTC**



10mm Offset  
Extension  
Adjustable Length  
3½"/90mm Outlet

Code **WC-EXTD**

## Straight Telescopic WC Socket Extension

- Short telescopic socket extension connector to fit the socket of any MACFIT, Rigid or Flexible WC connector
- Can extend a WC connector already installed and requiring alteration before final placement to the WC pan
- Provides adjustment to the required length where soil pipe already installed



Overall length of telescopic socket extension piece  
133mm

Code WC-CON-EXT

## WC Connector Accessories

### Boss Pipe for use with WC Connectors

- Finned seal spigot for internal connection to cast iron, plastic or clay 4"/110mm pipe
- Ideal for low level connections



**3½"/90mm x 4"/110mm Connector** with 'O' seal socket to fit any M<sup>C</sup>Alpine rigid or flexible WC connector with 4"/110mm rubber outlet seal when rubber seal is removed. With 1½" universal pipe boss including blanking cap. *As illustrated opposite with WC-CON8 (cut down to required length)*

Code WC-BP1



**Anti Cross-Flow and Rodent Barrier Valve**

- Will prevent cross-flow if fitted to WC pans that are installed back to back
- For use where special measures are necessary for control of rodents as recommended in Approved Document H1 The Building Regulations 2000 (2002 edition)
- Manufactured in black polypropylene to prevent light penetration
- Deters rodents from entering building through WC
- For use with any M<sup>C</sup>Alpine rigid or flexible WC connector with 4"/110mm rubber outlet seal
- Can be installed in horizontal or vertical position



Open position

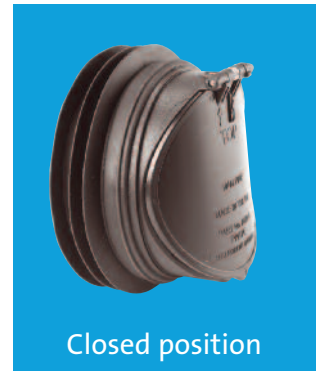

Closed position

Code **ARB-1**

**WC Connector Wall Flange**



To fit over Rigid WC Connector with 4"/110mm Rubber Seal Outlet

Code **WC17-90**

To fit over 4"/110mm Soil Pipe or Rigid WC Connectors with Plain End Outlet

Code **WC17-110**

To fit over Collar of Flexible WC Connector

Code **WC17-114**

**WC Frame Connector Kit**



**WC Frame Connector Kit** comprises WC connector with 90mm end, 110mm outlet seal, flush pipe with finned seal connector and fixing bolts and caps. Suitable for in-wall WC frames

Code **FPKIT-3**



## Air Admittance Valves (Ventapipe)

SECTION

6



Air Admittance Valves (Ventapipe)



# Air Admittance Valves (Ventapipes)

## Air Admittance Valves (Ventapipes)

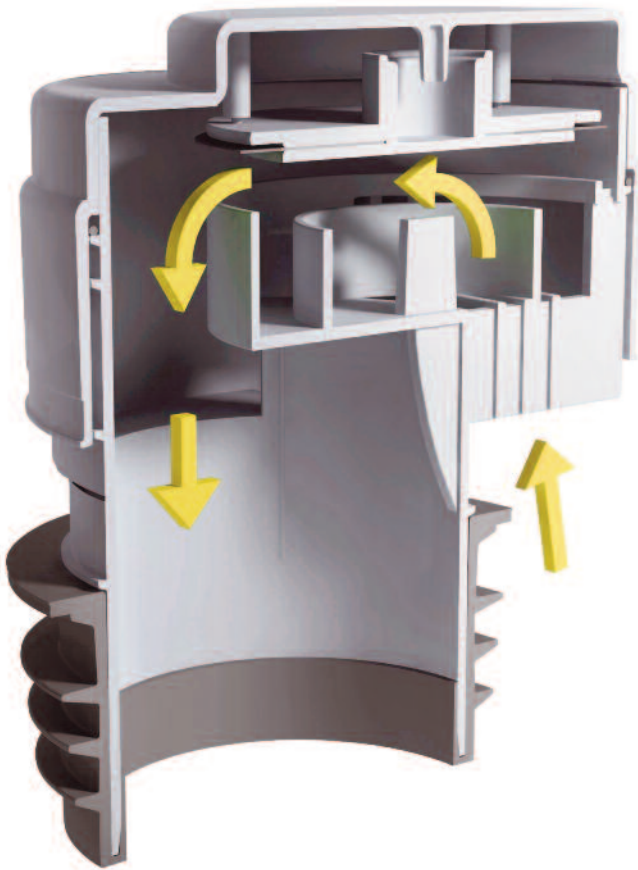

Valve open

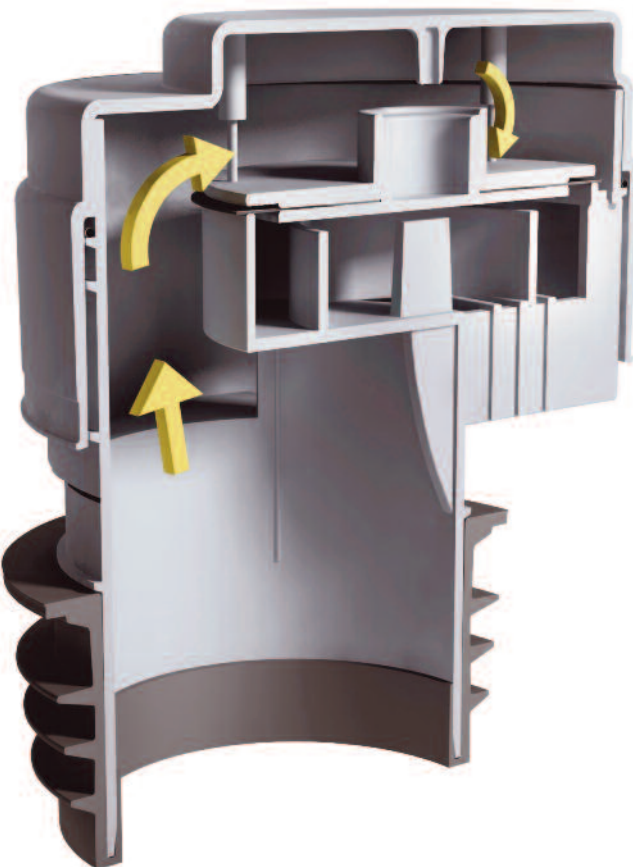

Valve closed

Code **VP100**

## Ventapipes 100 and Ventapipes 50 Application

Ventapipes 100 and Ventapipes 50 Air Admittance Valves are for use in above ground drainage systems. They are designed to:

- Provide a means of ventilation to the drainage system under conditions of reduced pressure when ventilating pipes are terminated inside buildings in accordance with BS EN 12056-2:2000

### Operation

The two diagrams illustrate how Ventapipes functions. The valve diaphragm lifts and allows air to be drawn into the system when it is subjected to negative pressure. On cessation of negative pressure the diaphragm returns to the closed position thereby preventing the escape of foul air into the building.

The valve is designed to open and close spontaneously when required thereby allowing a supply of air to adequately ventilate the system thus ensuring a smooth discharge.

### Approval

Approved Document H of The Building Regulations 2000 (2002 edition) requires that air admittance valves comply with BS EN 12380:2002.

All M<sup>C</sup>Alpine Ventapipes air admittance valves listed have been independently tested by the LGA Testing House and certified as being compliant with BS EN 12380:2002 and designated as Class A1.

This means that Ventapipes can be installed:

- Above or below the flood level of connected appliances
- Ventapipes has an operating temperature range of -20°C to + 60°C
- Ventapipes was granted A1 classification without the necessity of a polystyrene cover
- Ventapipes has been tested at -250 Pa for their air flow capacity and the flow rate is stated alongside each valve listed

### Quality Certificate

The LGA Quality Certificate certifies a product's high and consistent quality. It confirms the performance capability (functional characteristics, wear and tear and service life) of a product and therefore its comprehensive quality. Annual production inspections ensure its consistent quality. Whenever the LGA Quality Certificate is on a product it ensures it has been thoroughly tested.



### Advantages

- Ventapipe enables ventilating pipes to be terminated inside the building thereby avoiding roof penetration
- Ventapipe allows greater flexibility in design of new drainage systems
- Ventapipe allows greater flexibility when installing additional appliances to existing drainage systems
- Ventapipe eliminates problems of freezing associated with external pipes
- Ventapipe is suitable for use with either plastic or metal pipes
- Ventapipe offers cost savings in both material and labour

### Information for General Guidance only

- Underground foul drainage should be ventilated by a flow of air. A ventilating pipe should be provided at or near the head of each main drain
- An open ventilating pipe, without an air admittance valve, should be provided on any drain fitted with an intercepting trap, particularly on a sealed system and on any drain subject to surcharge
- Air admittance valves should not be used when the soil stack provides the only ventilation to septic tanks or cesspools
- Air admittance valves should not be used where there is no open ventilation on a drainage system or through connected drains and therefore alternative arrangements to relieve positive pressures should be considered
- Air admittance valves should not be used outside buildings or in dust laden atmospheres. They should be located preferably in a

non-habitable space, such as a duct or roof. The space should have adequate ventilation and be accessible for maintenance

- Air admittance valves should be removable to give access for clearance of blockages
- Air admittance valves can indicate the probability of blockages within the drainage system. This can be indicated by high water levels in WC bowls following flushing and the slow draining of appliances upstream from the blockage
- Sizes and limitations upon the use of air admittance valves are subject to national and local regulations and practice. If further detail is required check with the local authority building control office
- Kinetic ram guns should not be used to shift blockages on installations where air admittance valves are fitted as undue pressure and blowback may cause malfunction

### Ventapipe 15, 25, 40 and 50 Application

VP15, 25, 40 and 50 air admittance valves can be used as alternatives to anti-siphon and resealing traps to ventilate the waste pipe system in order to overcome problems such as noisy discharge or loss of trap seal caused by induced or self-siphonage. They are particularly advantageous when installing additional appliances to existing waste pipe(s).



Code VP100

# Air Admittance Valves (Ventapipe)

Air Admittance Valves (Ventapipe)

Code	Class	Air Flow Capacity (Litres per second)	Colour
------	-------	--	--------



**Ventapipe 100** with dual-fit synthetic rubber finger seal outlet for 3"/75mm or 4"/110mm pipe  
 4"/110mm pipe - push over rubber seal  
 3"/75mm pipe - push into rubber seal



<b>VP100</b>	A1	47.2	Grey
--------------	----	------	------



**Ventapipe 100** with solvent weld outlet for 4"/110mm pipe



<b>VP100N</b>	A1	19.4	Grey
---------------	----	------	------



**Ventapipe 50** with dual-fit synthetic rubber finger seal outlet for 3"/75mm or 4"/110mm pipe. Also incorporates 2" universal compression outlet  
 4"/110mm pipe - push over rubber seal  
 3"/75mm pipe - push into rubber seal



<b>VP50-100</b>	A1	16.3	Grey
-----------------	----	------	------



**Ventapipe 50** with dual-fit synthetic rubber finger seal outlet for 3"/75mm or 4"/110mm pipe  
 4"/110mm pipe - push over rubber seal  
 3"/75mm pipe - push into rubber seal



<b>VP50P</b>	A1	15.5	Grey
--------------	----	------	------



**Ventapipe 50** with 2" universal compression outlet



<b>VP50</b>	A1	14.2	Grey
-------------	----	------	------



**Ventapipe 40/50** solvent weld outlet for 1 1/4", 1 1/2" or 2"  
 BS EN 1329-1:2000 solvent weld waste pipe



<b>VPSF-40/50</b>	A1	9.1	White
-------------------	----	-----	-------

Code	Class	Air Flow Capacity (Litres per second)	Colour
------	-------	--	--------



**Ventapipe 25** with 1½" BSP thread on outlet



<b>VP1</b>	A1	3.0	Grey
<b>VP1W</b>	A1	3.0	White



**Ventapipe 25** with 1½" universal compression outlet



<b>VP2</b>	A1	3.0	Grey
<b>VP2W</b>	A1	3.0	White



**Ventapipe 25** with integral 1½" Multifit tee

<b>VP3</b>	-	4.5	White
------------	---	-----	-------



**Ventapipe 25** with integral 1¼" Multifit tee

<b>VP4</b>	-	2.0	White
------------	---	-----	-------



**Ventapipe 15** with 1¼" universal compression outlet

<b>VP15M</b>	-	0.5	Grey
--------------	---	-----	------



# Air Admittance Valves (Ventapipes)

## Internal/External Air Admittance Valve for 110mm Soil Pipe

- Incorporates a stainless steel mesh in the air intake which eliminates insect and debris ingress
- Complies with BS EN 12380:2002
- Designation Class A1
- Air Flow Capacity (litres per second) 40
- Range of temperature: -20°C to +60°C
- Can be installed above or below the flood level of connecting appliances
- LGA Quality Certificate - certifies the product's high and constant quality and confirms the performance capability



Code	Class	Air Flow Capacity (Litres per second)	Colour
<b>Ventapipe 100</b> with dual-fit synthetic rubber finger seal outlet for 4"/110mm pipe			
<b>VP100E</b>	A1	40	Black



### Internal Air Admittance Valve

McAlpine recommends that Air Admittance Valves be installed internally within the building.

AAVs should be located preferably in a non-habitable space such as a duct or roof space with adequate ventilation and must be accessible for maintenance.

AAVs must be installed in the vertical position.

#### Internal Advantages

- Enables ventilating pipes to be terminated inside the building thereby avoiding roof penetration
- Allows greater flexibility in design of new drainage systems
- Allows greater flexibility when installing additional appliances to existing drainage systems
- Eliminates problems of freezing associated with external pipes
- Suitable for use with either plastic or metal pipes
- Offers cost savings in both material and labour

### External Air Admittance Valve

Although there are no regulations for an AAV to be installed externally, it may be advantageous in certain circumstances, be it design or otherwise, to allow installation into an external soil stack and some of the advantages are as follows:

#### External Advantages

- The external soil stack may be terminated below the roofline which reduces the amount of soil pipe and fittings required
- The AAV may be installed at a minimum height of 200mm above the highest wet branch connection
- Fitted externally the AAV is easy to access for maintenance if required
- Reduces installation time and materials
- It may be prudent to seek guidance from the local building department

Valve open

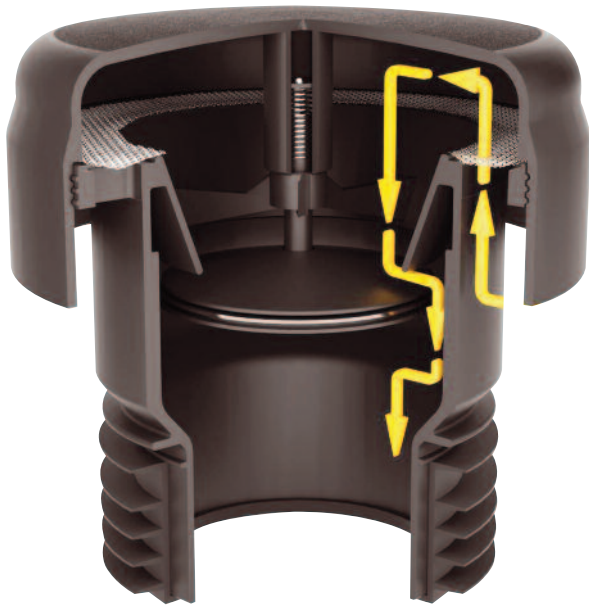

Valve closed

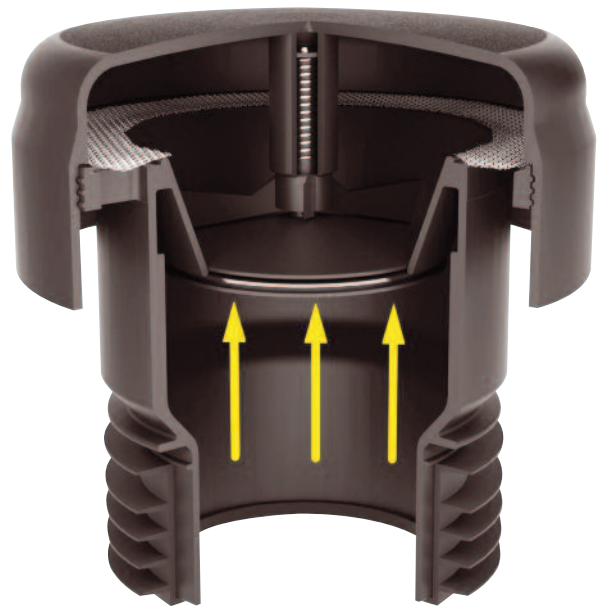
**Operation**

The two diagrams illustrate how Ventapipe functions. The valve diaphragm lifts and allows air to be drawn into the system when it is subjected to negative pressure. On cessation of negative pressure the diaphragm returns to the closed position thereby preventing the escape of foul air into the building.

The valve is designed to open and close spontaneously when required thereby allowing a supply of air to adequately ventilate the system thus ensuring a smooth discharge.

### Illustrations from BS EN 12056-2:2000 Gravity Drainage Systems Inside Buildings to demonstrate installation variations for Air Admittance Valves

#### Primary Ventilated System Configuration

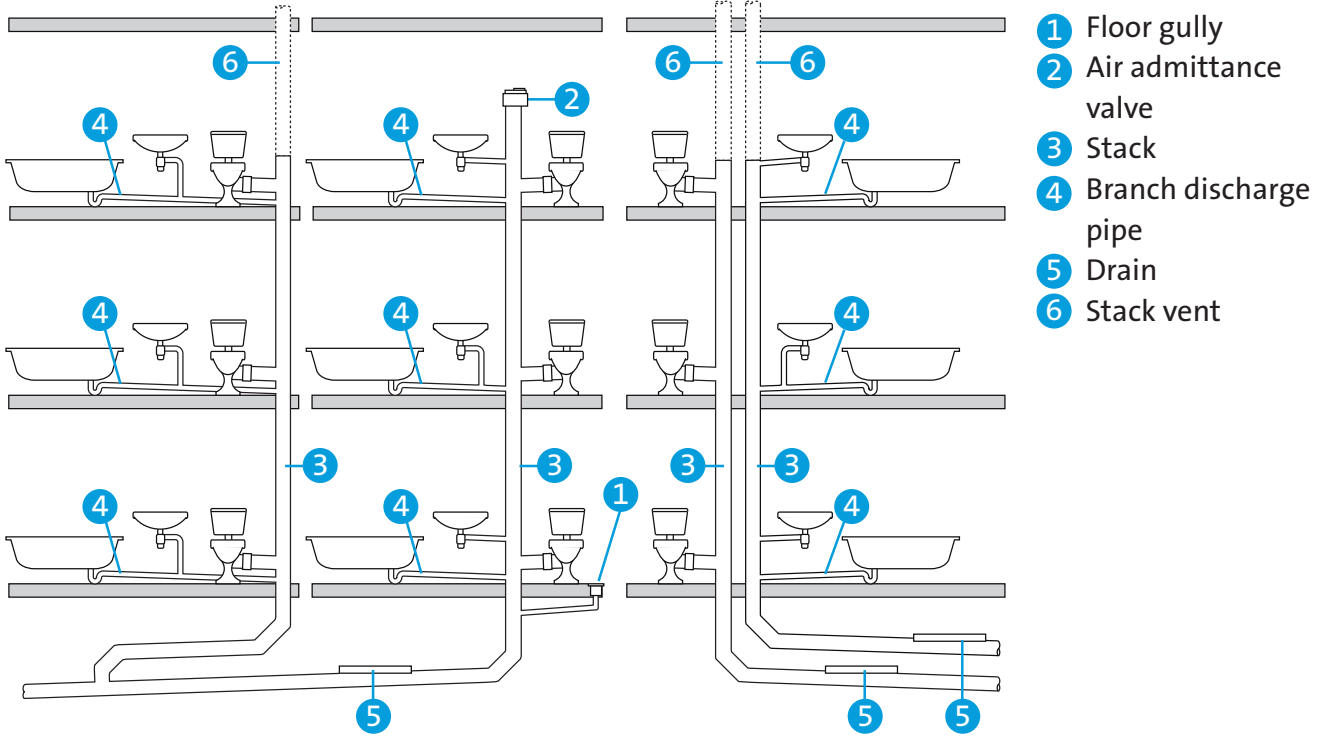

#### Secondary Ventilated System Configuration

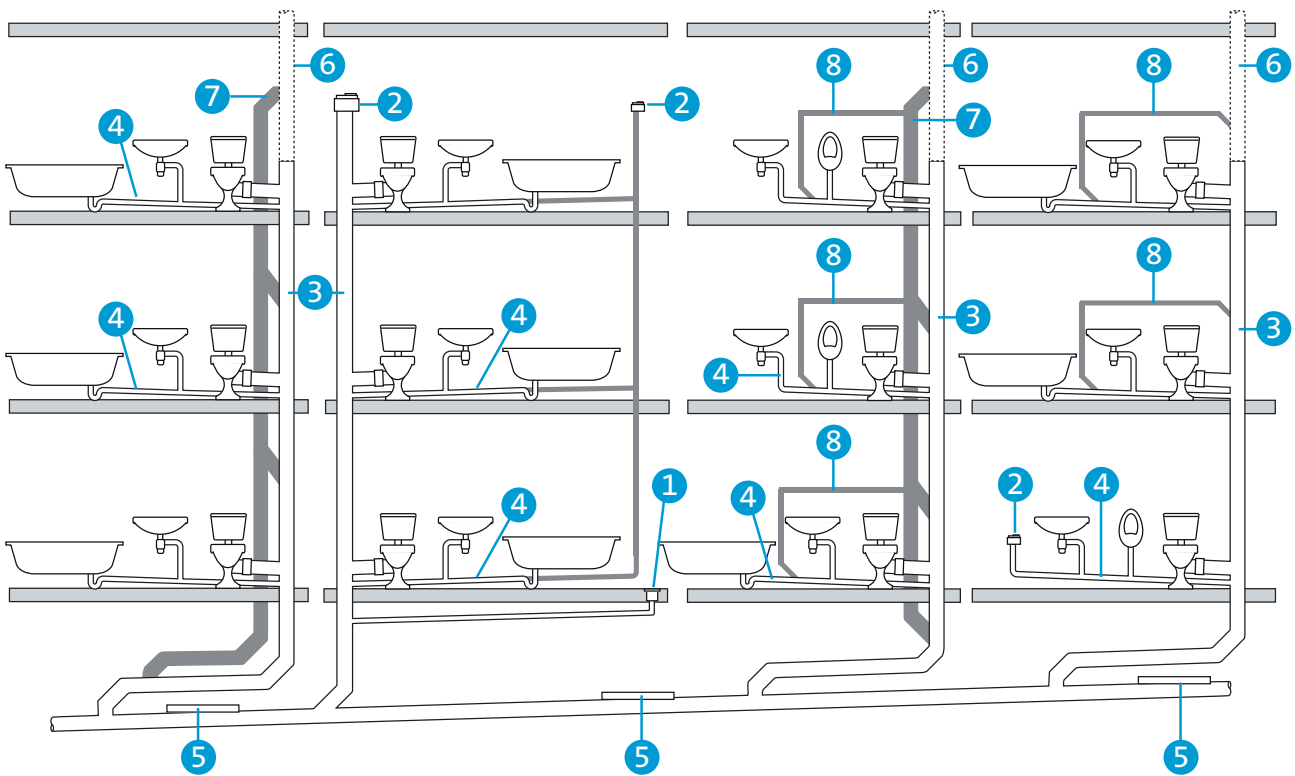

Control of pressure in the discharge stack is achieved by use of separate ventilating stacks and/or secondary branch ventilating pipes in connection with stack vents. Alternatively, air admittance valves may be used.







# Waste Outlet Fittings

## General

- Waste outlets are moulded in polypropylene unless otherwise stated
- Centre pin models are supplied with dry fixing washers and backnut models are supplied with backnuts and washers
- Centre pin and backnut models are supplied with PVC plugs unless otherwise stated
- Waste outlets incorporating an overflow are supplied with flexible tube with an OD of 25mm unless otherwise stated
- All chains are supplied with two triangles

## Chrome Plated Brass Basin Wastes with Chrome Plated Brass Backnuts



**Backnut Model** 1 1/4" x 60mm flange x 3 1/2" slotted tail with spring-loaded mushroom plug

Code **CW60-CB**



**Backnut Model** 1 1/4" x 60mm flange x 3 1/2" slotted tail with swivel plug

Code **CW60SP-CB**

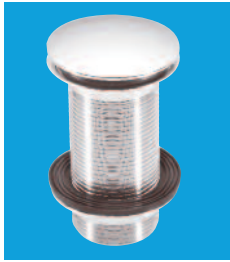

**Backnut Model** 1 1/4" x 60mm flange x 3 1/2" unslotted tail with spring-loaded mushroom plug

Code **CWU60-CB**

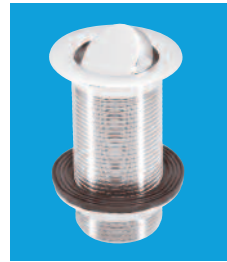

**Backnut Model** 1 1/4" x 60mm flange x 3 1/2" unslotted tail with swivel plug

Code **CWU60SP-CB**



**Backnut Model** 1 1/4" x 60mm flange x 3 1/2" unslotted tail, free flowing (open) with mushroom cover plate

Code **DWU60-CB**



**Backnut Model** 1 1/4" x 60mm flange x 3 1/2" slotted tail with swivel handle plug

Code **BW60SPH-CB**



**Backnut Model** 1 1/4" x 60mm flange x 3 1/2" slotted tail with square spring-loaded plug

Code **CW60SQ-CB**



**Backnut Model** 1 1/4" x 60mm flange x 3 1/2" unslotted tail with swivel handle plug

Code **BWU60SPH-CB**

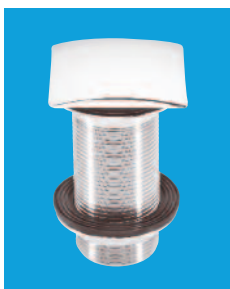

**Backnut Model** 1 1/4" x 60mm flange x 3 1/2" unslotted tail with square spring-loaded plug

Code **CWU60SQ-CB**



**Extended Backnut** 1 1/4" x 55mm tail: threaded shroud and extension piece

Code **GWAL-CB**

### Centre Pin Basin Wastes - Multi Function with Stainless Steel Flange and Plug

- Centre pin dry fixing connection for a quick and simple installation
- Suitable for basins with or without overflow
- Polished stainless steel mushroom plug
- CP brass or white plastic waste body

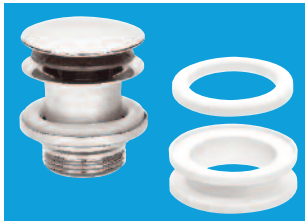

#### Centre Pin Model

	Code
1¼" x 60mm polished stainless steel flange with spring-loaded mushroom plug - CP brass body	<b>CWP60-SS</b>

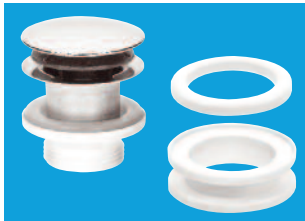

#### Centre Pin Model

	Code
1¼" x 60mm polished stainless steel flange with spring-loaded mushroom plug - white plastic body	<b>CWP60-SSP</b>

### Centre Pin Basin Wastes - Stainless Steel Flange

- The centre pin dry fixing connection has the advantage of a quick, simple and neat installation and affords a saving in material and labour costs. Additionally the polished stainless steel flange eliminates the problem of chrome plating deterioration



#### Centre Pin Model

	Code
1¼" x 60mm flange with plug	<b>BSW1P</b>
1¼" x 60mm flange, plug with CP chain and stay	<b>BSW1PC</b>
1½" x 60mm flange with plug	<b>BSW2P</b>
1½" x 60mm flange, plug with CP chain and stay	<b>BSW2PC</b>



#### Centre Pin Model with backnut and washer for basin bracket if required

1¼" x 60mm flange with plug	<b>BSW11P</b>
1¼" x 60mm flange, plug with CP chain and stay	<b>BSW11PC</b>

### Backnut Basin Wastes - Chrome Plated Plastic



#### Backnut Model

1¼" x 60mm flange x 3½" slotted tail with plug	<b>BW1</b>
1¼" x 60mm flange x 3½" unslotted tail with plug	<b>BW1A</b>



#### Backnut Model

1¼" x 60mm flange x 3½" slotted tail with CP plug	<b>CW1</b>
---	------------

# Basin Waste Outlets

## Backnut Basin Wastes



Stainless steel flange - white plastic body

Code

1 1/4" x 60mm flange x 3 1/2" slotted tail with plug

**BSW1**

1 1/4" x 60mm flange x 3 1/2" unslotted tail with plug

**BSW2**



Stainless steel flange - black plastic body

1 1/4" x 60mm flange x 3 1/2" slotted tail with plug

**BSW12**

1 1/4" x 60mm flange x 3 1/2" slotted tail, plug with triangle

**BSW12T**

1 1/4" x 60mm flange x 3 1/2" slotted tail, plug with CP chain and stay

**BSW12C**



White plastic

1 1/4" x 60mm flange x 3 1/2" slotted tail with plug

**W1**

1 1/4" x 60mm flange x 3 1/2" unslotted tail with plug

**W1A**

## Combined Wastes and Overflows for Vanity Basin

Centre Pin Models - stainless steel flange

Banjo Model - white plastic



1 1/4" x 60mm flange, CP overflow grid, plug and CP chain

Code

**FVW1P\***



1 1/4" x 60mm flange, CP overflow grid, plug and CP chain

Code

**FVW1PC**



1 1/4" x 60mm flange x 3 1/2" tail, plug and CP chain

Code

**FVW1PW**

Basin Waste Outlets

\* Nut and bolt overflow connection and compression connection to flexible tube

### Bath Wastes



**Backnut Model** CP brass 1 1/2" x 70mm flange x 44mm tail with spring-loaded mushroom plug

Code **CBW70-CB**



**Centre Pin Model** 1 1/2" x 70mm CP brass flange x 60mm tail with spring-loaded mushroom plug

Code **CWS70-CB**



**Backnut Model** 1 1/2" x 70mm CP brass flange x 58mm tail with swivel plug

Code **CBW70-SW**



**Backnut Model** 1 1/2" x 70mm CP brass flange x 58mm tail with spring-loaded mushroom plug

Code **CBW70-CLK**



**Combined Waste and Overflow Centre Pin Model** 1 1/2" x 70mm CP brass flange x 60mm tail with spring-loaded mushroom plug and matching overflow cover plate

Code **CBWF70CB**

### Centre Pin Bath Wastes - Stainless Steel Flange



**Centre Pin Model**

1 1/4" x 70mm flange with plug

Code **BSW9P**



1 1/4" x 70mm flange with plug and CP chain

Code **BSW9PC**



1 1/2" x 70mm flange with plug

Code **BSW10P**

1 1/2" x 70mm flange with plug and CP chain

Code **BSW10PC**



1 1/2" x 70mm flange with plug

Code **BSW15P**



1 1/2" x 70mm flange with plug and CP chain

Code **BSW15PC**

### Backnut Bath Wastes



**Backnut Model** - stainless steel flange

1 1/2" x 70mm flange x 1 1/2" unslotted tail with plug

Code **BSW10**



**Backnut Model** - chrome plated plastic

1 1/2" x 70mm flange x 1 1/2" unslotted tail with plug

Code **BW5**

1 1/2" x 70mm flange x 1 1/2" unslotted tail with CP plug

Code **CW5**



**Backnut Model** - white plastic

1 1/4" x 70mm flange x 1 1/2" unslotted tail with plug

Code **W4**

1 1/2" x 70mm flange x 1 1/2" unslotted tail with plug

Code **W5**

■ All the above waste outlet fittings are suitable for use with traps listed on pages 18-19



# Pop-Up Bath Wastes and Overflows

## Pop-Up Bath Wastes and Overflows, Centre Pin Models - Stainless Steel Flange



1½" x 70mm flange with CP brass overflow/command knob

Code **PUB-CPB**



1½" x 70mm CP flange and mushroom plug with CP brass overflow/command knob

Code **PUB-CPX**

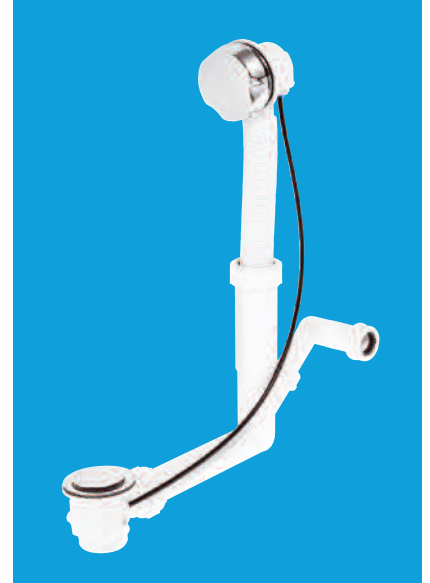

1½" x 70mm CP stainless steel flange, CP brass control knob and mushroom plug. Side inlet connection for 19/23mm condensate or condense drain

Code **PUBX-SP**

1½" x 70mm flange with CP plastic overflow/command knob

Code **PUB-CP**

1½" x 70mm colour matched white plastic flange and overflow/command knob

Code **PUB-WH**

■ The CBWF70-CB and all pop-up bath wastes have 34mm diameter overflow tubes

### Push Button Bath Pop-Up Waste with Trap and Overflow

- CP brass overflow with push button action to operate CP brass mushroom plug
- 1½" x 50mm water seal trap with Multifit outlet
- Overall height of trap 110mm
- Cable and overflow length 575mm, 700mm and 1m
- Compression overflow connection to trap

Code **PUB-PB-575**

Code **PUB-PB-700**

Code **PUB-PB-1M**



### Combined Wastes and Overflows

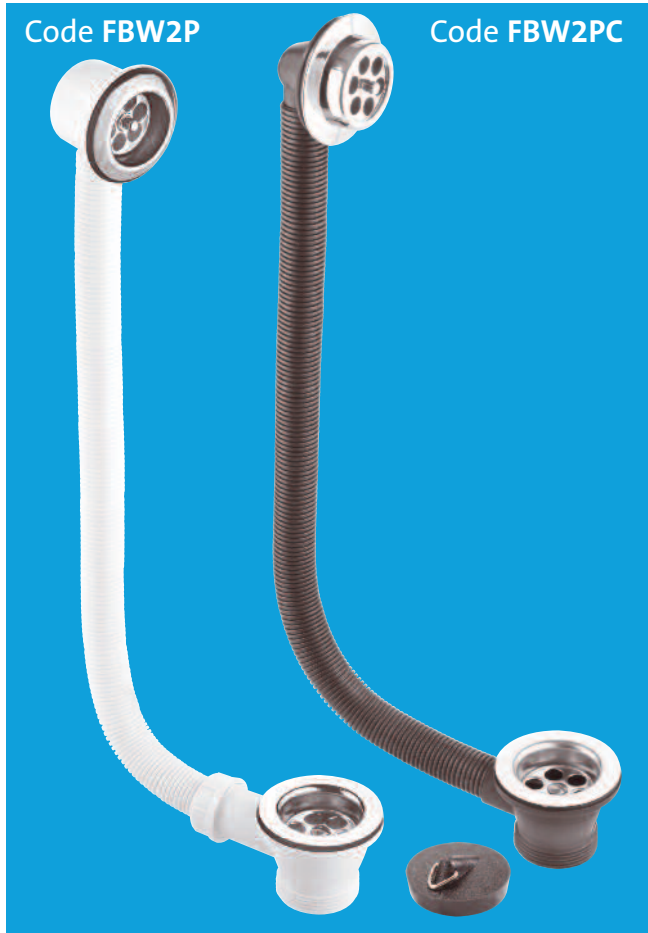

**Centre Pin Model** - stainless steel flange

	Code
1¼" x 70mm flange, SS overflow grating, plug and CP chain	<b>FBW1P*</b>
1½" x 70mm flange, SS overflow grating, plug and CP chain	<b>FBW2P*</b>

\* Nut and bolt overflow connection and compression connection to flexible tube

1¼" x 70mm flange, CP overflow grating, plug and CP chain	<b>FBW1PC</b>
1½" x 70mm flange, CP overflow grating, plug and CP chain	<b>FBW2PC</b>

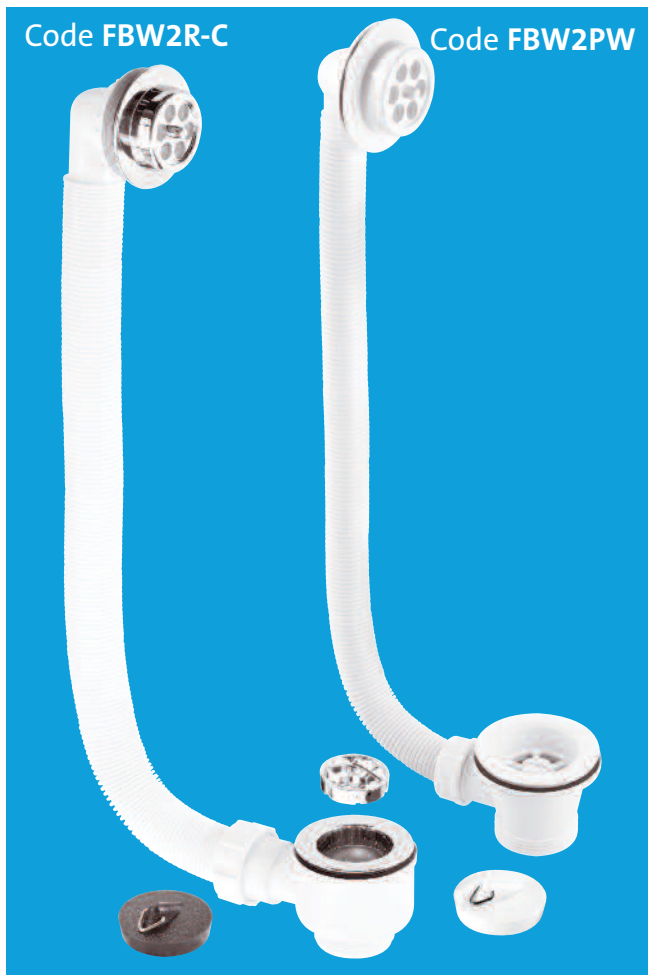

**Combined Wastes and Overflows with removable Grid for cleaning**

1½" x 70mm CP plastic flange, CP overflow grating and 34mm diameter overflow tube, plug and CP chain	<b>FBW2R-C</b>
1½" x 70mm white plastic flange and 34mm diameter overflow tube, plug and CP chain	<b>FBW2R-W</b>

**Centre Pin Model**

1½" x 70mm white plastic waste and overflow, plug and CP chain	<b>FBW2PW</b>
--	---------------

■ All the above waste outlet fittings are suitable for use with traps listed on page 18

# Sink Waste Outlets

## Centre Pin Sink Wastes - Stainless Steel Flange



### Centre Pin Model

	Code
1 1/4" x 85mm flange with plug	<b>BSW3P</b>
1 1/4" x 85mm flange, plug with CP chain and stay	<b>BSW3PC</b>
1 1/2" x 85mm flange with plug	<b>BSW6P</b>
1 1/2" x 85mm flange, plug with CP chain and stay	<b>BSW6PC</b>



### Centre Pin Model

1 1/2" x 85mm flange with black PVC handle plug	<b>BSW6PR</b>
---	---------------



### Centre Pin Model

1 1/2" x 70mm flange with black PVC handle plug	<b>BSW10PR</b>
---	----------------



### Centre Pin Model

2" x 85mm flange with plug	<b>BSW21P</b>
2" x 85mm flange, plug with CP chain and stay	<b>BSW21PC</b>



### Centre Pin Model Waste for Belfast Sink

1 1/2" x 85mm flange with CP handle plug	<b>BSW6CP2H</b>
--	-----------------



### Centre Pin Model Reducer Waste

1 1/2" x 113mm flange with black ABS handle plug	<b>SW45P</b>
1 1/2" x 113mm flange, plug with CP chain and stay	<b>BSW45P</b>

## Backnut Sink Waste



### Backnut Model - white plastic

1 1/2" x 85mm flange x 3 1/2" unslotted tail with plug	<b>W3</b>
--	-----------



**Centre Pin Model** - stainless steel flange

Code

1¼" x 85mm flange, CP overflow grid, plug and CP chain

**FSW1PC**

1½" x 85mm flange, CP overflow grid, plug and CP chain

**FSW2PC**

1½" x 70mm flange, CP overflow grid, plug and CP chain

**FSW2PC-70**



**Centre Pin Model** - stainless steel flange

1¼" x 85mm flange, black overflow grid, plug and CP chain

**FSW1PP**

1½" x 85mm flange, black overflow grid, plug and CP chain

**FSW2PP**

1½" x 70mm flange, black overflow grid, plug and CP chain

**FSW2PP-70**



**Centre Pin Model** - stainless steel flange

1½" x 85mm flange, rectangular overflow (no overflow grid), plug with CP chain and stay, supplied with reversible dual purpose overflow washer for curved or flat sink bowl

**FSW2PR**

1½" x 70mm flange, rectangular overflow (no overflow grid), plug with CP chain and stay, supplied with reversible dual purpose overflow washer for curved or flat sink bowl

**FSW2PR-70**



**Centre Pin Model** - stainless steel flange

1¼" x 85mm flange, CP overflow grid, plug with CP chain and stay

**FSW1P\***

1½" x 85mm flange, CP overflow grid, plug with CP chain and stay

**FSW2P\***

\* Nut and bolt overflow connection and compression connection to flexible tube



**Reducer Waste and Overflow**  
**Centre Pin Model** - stainless steel flange

1½" x 113mm flange, CP overflow grid, plug and CP chain

**FSW45P**



# Basket Strainer Wastes

## Basket Strainer Wastes



**Centre Pin Model** - stainless steel flange  
**Stemball plug**

1½" x 113mm flange

Code

**BWSTSS**

1½" x 113mm flange, PVD finish (gold)

**BSWPVD**



**Centre Pin Model** - stainless steel flange  
**Spring-Loaded plug**

1½" x 113mm flange

**BSWCLS**



**Backnut Model** - chrome plated brass  
**Spring-Loaded plug**

1½" x 113mm flange

**BSW-BR-CP**



**Basket Strainer Waste and Overflow**  
**Centre Pin Model** - stainless steel flange  
**Stemball plug**

1½" x 113mm flange, rectangular overflow,  
(no overflow grid)

**BWSTOFRS**

1½" x 113mm flange with CP overflow grid

**BWSTOFSS**

1½" x 113mm flange, overflow grid, PVD finish (gold)

**FBSWPVD**

**Centre Pin Model** - stainless steel flange  
**Spring-Loaded plug**

1½" x 113mm flange with CP overflow grid

**BSWCLS-OFSS**



**Mini Basket Strainer Waste**  
**Centre Pin Model** - stainless steel flange  
**Stemball plug**

1½" x 85mm flange

**MBSWSS85**

1½" x 85mm flange, PVD finish (gold)

**MBS85PVD**



**Mini Basket Strainer Waste and Overflow**  
**Centre Pin Model** - stainless steel flange  
**Stemball plug**

1½" x 85mm flange with CP overflow grid

**FMBSWSS85**

- Basket strainer wastes are supplied with a 41mm long fixing ferrule and mini basket strainer wastes with a 55mm long fixing ferrule. Longer fixing ferrules available as follows: 70mm long Code: BRBOLT70 and 90mm long Code: BRBOLT90



**Stainless Steel Strainer plug for Basket Strainer Waste stemball model**

Code	<b>BWSTSS-TOP</b>
------	-------------------



**Stainless Steel Strainer plug for Basket Strainer Waste with rubber finger seal connection**

Code	<b>BSKTOP</b>
------	---------------

## Pop-Up Sink Wastes



**Pop-Up Wastes and Overflows Centre Pin Model** - stainless steel flange

	Code
1½" x 70mm flange with CP plastic command knob	<b>PUS70-CP</b>
1½" x 70mm flange, flexible overflow, CP plastic grid and command knob	<b>PUFS70-CP</b>



**Pop-Up Basket Strainer Wastes and Overflows Centre Pin Model** - stainless steel flange

1½" x 113mm flange basket strainer waste with CP plastic command knob	<b>PUS113-CP</b>
1½" x 113mm flange basket strainer waste, flexible overflow, CP plastic grid and command knob	<b>PUFS113-CP</b>

# Shower Waste Outlets

## Centre Pin Shower Wastes - Stainless Steel Flange



**Centre Pin Model** - stainless steel flange

Code

1¼" x 70mm flange

**BSW9P-F**

1½" x 70mm flange

**BSW10P-F**

## Backnut Wastes

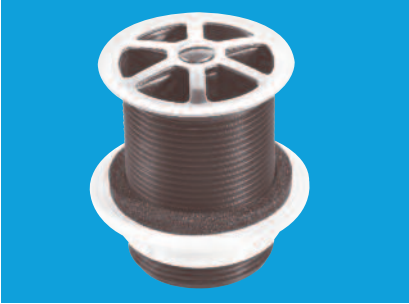

**Backnut Model** - stainless steel flange

1½" x 60mm flange x 70mm tail

**CSWU3P**



**Backnut Model** - CP plastic

1½" x 70mm flange x 1½" tail

**CWS5**



**Backnut Model** - white plastic

1½" x 70mm flange x 1½" tail

**WS5**



**Backnut Model** - white plastic

1½" x 85mm flange x 3½" tail

**WS3**



**High-Flow Shower Waste - Top Access Backnut Model** - white plastic

1½" x 113mm flange x 2¾" tail

**SWHF1-WH**

2" x 113mm flange x 2¾" tail

**SWHF2-WH**



Code **SWHF3-CP**

**High-Flow Shower Waste - Top Access Backnut Model - standard cover flange**

	Code
1½" x 113mm flange x 2¾" white plastic flange	<b>SWHF3-WH</b>
1½" x 113mm flange x 2¾" CP plastic flange	<b>SWHF3-CP</b>
2" x 113mm flange x 2¾" white plastic flange	<b>SWHF4-WH</b>
2" x 113mm flange x 2¾" CP plastic flange	<b>SWHF4-CP</b>



Code **SWHF6-WH**

**High-Flow Shower Waste - Top Access Backnut Model - plain cover flange**

1½" x 113mm flange x 2¾" white plastic flange	<b>SWHF5-WH</b>
1½" x 113mm flange x 2¾" CP plastic flange	<b>SWHF5-CP</b>
2" x 113mm flange x 2¾" white plastic flange	<b>SWHF6-WH</b>
2" x 113mm flange x 2¾" CP plastic flange	<b>SWHF6-CP</b>

Code **BSW10P-F**



Code **CSWU3P**



Code **CWS5**





## Pumped Shower Waste Outlets

### Untrapped Shower Wastes with Top Access

- For use with pumped waste where normal gravity discharge is not possible



**Centre Pin Model** - 70mm polished stainless steel flange with plastic strainer grid and 15mm 'O' ring pushfit outlet

Code	<b>UPSW-1</b>
------	---------------



70mm CP brass flange with top access x 15mm plain tail outlet

Code	<b>UPSW-2</b>
------	---------------



85mm CP brass flange with top access x 15mm plain tail outlet

Code	<b>UPSW-3</b>
------	---------------



70mm CP brass flange with top access x 22mm plain tail outlet

Code	<b>UPSW-2-22MM</b>
------	--------------------

85mm CP brass flange with top access x 22mm plain tail outlet

Code	<b>UPSW-3-22MM</b>
------	--------------------



113mm CP brass flange with top access x 22mm plain tail outlet

Code	<b>UPSW-4-22MM</b>
------	--------------------



Code **UPSW-3-22MM**

### Backnut Urinal Wastes



**Backnut Model** - domed flange

	Code
1¼" x 60mm flange x 3½" white plastic tail	<b>WU10</b>
1½" x 60mm flange x 2" white plastic tail	<b>WU11</b>



**Backnut Model** - domed flange with removable dome

2" x 85mm flange x 1⅝" grey plastic tail	<b>GWU20</b>
2" x 85mm flange x 1⅝" white plastic tail	<b>WU20</b>

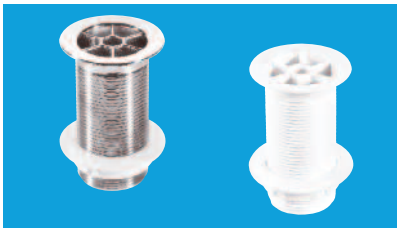

**Backnut Model** - flush flange

1¼" x 60mm flange x 3½" CP plastic tail	<b>CWU1A</b>
1¼" x 60mm flange x 3½" white plastic tail	<b>WU1A</b>



**Backnut Model** - flush flange

1¼" x 60mm flange x 2⅛" CP plastic tail	<b>CWU1S</b>
1¼" x 60mm flange x 2⅛" white plastic tail	<b>WU1S</b>

### Waste with plug for Caravans and Boats











This waste has a plain tail and can be fitted into any 1¼" x 75mm water seal adjustable inlet trap - e.g. AA10 see page 6. Remove standard adjustable inlet supplied and substitute fitting

50mm plastic flange, ¾" BSP thread, plug with special locking nut **CTW1**

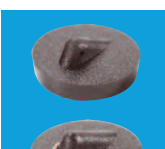



# Waste Accessories and Soap Dispenser

## Plugs

	<b>Black Plastic with Rubber Seal</b>	Code
	1 3/4" with handle	<b>BP2H</b>
	<b>Black PVC</b>	Code
	1 1/2" with handle	<b>BP3H</b>
	1 3/4" with handle	<b>BP4H</b>
	<b>White Plastic with Rubber Seal</b>	Code
	1 3/4" with handle	<b>WP2H</b>
	<b>CP Plastic with Rubber Seal</b>	Code
	1 1/2" with handle	<b>CP1H</b>
	1 3/4" with handle	<b>CP2H</b>
	<b>CP Plastic with Rubber Seal</b>	Code
	1 1/2"	<b>CP1</b>
	1 3/4"	<b>CP2</b>
	<b>Black PVC</b>	Code
	1 1/2"	<b>BP3</b>
	1 1/2" with triangle	<b>BP3T</b>
	1 3/4"	<b>BP4</b>
	1 3/4" with triangle	<b>BP4T</b>
	2"	<b>BP5</b>
	<b>White Plastic with Rubber Seal</b>	Code
	1 1/2"	<b>WP1</b>
	1 1/2" with triangle	<b>WP1T</b>
	1 3/4"	<b>WP2</b>
	1 3/4" with triangle	<b>WP2T</b>
	<b>White PVC</b>	Code
	1 1/2"	<b>WP3</b>
	1 1/2" with triangle	<b>WP3T</b>
	1 3/4"	<b>WP4</b>
	1 3/4" with triangle	<b>WP4T</b>
	<b>Captive Plug - Black Plastic</b>	Code
	1 1/2"	<b>BP1-CAP†</b>
	1 3/4"	<b>BP2-CAP†</b>

† Note: BP1-CAP and BP2-CAP are only for use with MCApine wastes which have a centre pin fixing



## Chains

	Code
10" CP chain and two triangles	<b>CH5</b>
	Code
16" CP chain and two triangles	<b>CH4</b>
	Code
18" CP chain and two triangles	<b>CH4-18</b>
	Code
10" CP chain and two triangles, stay and nut	<b>CH10</b>

## Backnuts

	<b>White Plastic with Rubber Washer</b>	Code
	1 1/4" x 60mm flange	<b>BN1</b>
	1 1/2" x 70mm flange	<b>BN2</b>
	1 1/2" x 85mm flange	<b>BN3</b>
	2" x 75mm flange	<b>BN5</b>

## Tap Hole Stoppers

	<b>Stainless Steel</b>	Code
	16mm long thread	<b>TAPSTOP-SS</b>
	40mm long thread	<b>TAPSTOP-SS40</b>
	<b>White Plastic</b>	Code
	17mm long thread	<b>TAPSTOP-WH</b>

## Overflow Stopper

	<b>Black Plastic</b>	Code
	17mm long thread	<b>O/FSTOP-BL</b>

## Soap Dispenser

	<b>Sink 1/2 litre bottle with CP plastic top</b>	Code
		<b>SOAP-CP</b>

### Card Description



- 1 Two Basin Plugs
- 2 Two Sink or Bath Plugs
- 3 Basin Plug, Chain & Stay
- 4 Bath Plug & Chain
- 5 Sink Plug & Chain
- 6 Chrome Plated Basin & Bath Plugs
- 7 Chrome Plated Handle Basin Plug
- 8 Chrome Plated Handle Sink or Bath Plug
- 9 White Handle Sink or Bath Plug
- 10 Indian Ivory Handle Sink or Bath Plug
- 11 Mocca Handle Sink or Bath Plug
- 12 Basin Chain & Stay
- 13 Bath Chain
- 14 White Pop-Up Plug
- 15 Indian Ivory Pop-Up Plug
- 16 Mocca Pop-Up Plug
- 17 Stainless Steel Pop-Up Plug
- 18 Tap Hole Stopper
- 19 Sink Overflow Stopper
- 20 1 1/4" Backnut & Washer
- 21 1 1/2" Backnut & Washer
- 22 Two 1 1/4" Multifit Washer Sets
- 23 Two 1 1/2" Multifit Washer Sets
- 24 Five 1 1/4" Rubber Washers
- 25 Five 1 1/2" Rubber Washers
- 26 1 1/2" x 1 1/4" Reducer
- 27 1 1/2" x 1 1/4" Trap Inlet Reducer
- 28 1 1/4" BSP Coupling 2" Long
- 29 1 1/2" BSP Coupling 2" Long
- 30 1 1/2" European to UK Waste Adaptor

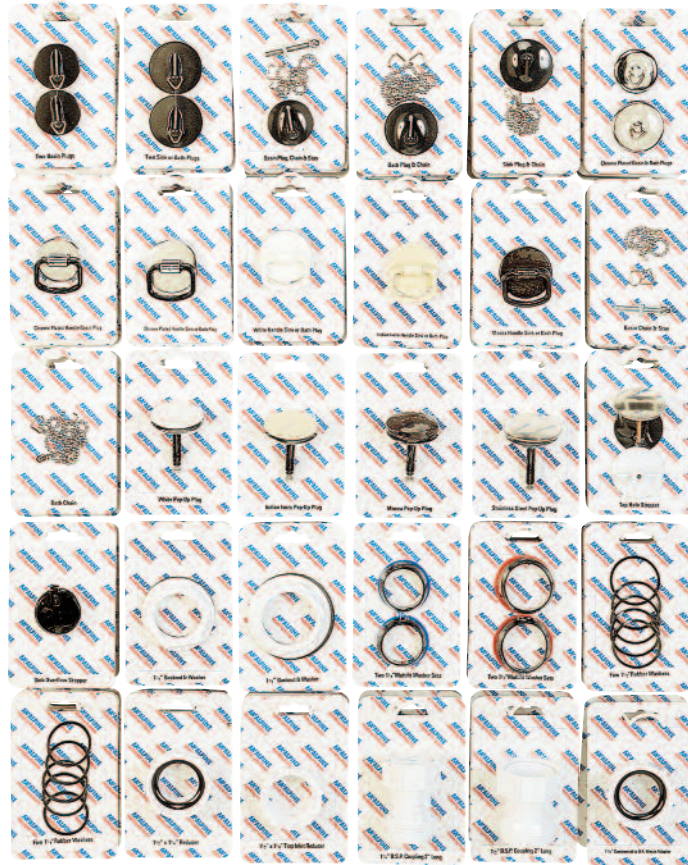

- 31 Five Rubber 'O' Rings for Shower Trap Dip Tube
- 32 Two CP Grids for Shower Traps
- 33 Two White Grids for Shower Traps
- 34 Two Gold Grids for Shower Traps
- 49 Stainless Steel Strainer Plug (Stemball)
- 50 White Strainer Plug
- 51 Indian Ivory Strainer Plug
- 52 Mocca Strainer Plug
- 53 Stainless Steel Strainer Plug
- 54 Gold Waste & Grid for M<sup>c</sup>Alpine Access Shower Trap
- 55 Tundish with 19/23mm Universal Compression Outlet
- 56 Side Inlet Tundish with 19/23mm Universal Compression Outlet
- 57 Top Inlet Tundish with 19/23mm Universal Compression Outlet
- 58 3/4" Overflow x 1 1/2" Flushpipe Tee
- 59 Nozzle for M<sup>c</sup>Alpine Washing Machine Trap
- 60 1 1/2" Tee Piece with Adaptor for Washing or Dishwashing Machine Discharge Hose







# Technical Details

## Installation Guidelines

- **Building Regulations** require that all points of discharge into a drainage system should be fitted with a trap (e.g. a water seal trap) to prevent foul air from the system entering the building. Under working and test conditions traps should retain a minimum seal of 25mm of water

## Installation Requirements

All traps, waste pipe, waste fittings and soil fittings when installed in buildings should be installed in compliance with:

- Building Regulations 2000 (2002 edition) Approved Document H England and Wales
- The Building Standards (Scotland) Regulations 1990 (as amended)
- The Building Regulations (Northern Ireland) 2000 Alternatively the relevant recommendations of BS EN 12056-2:2000 should be followed

All traps should be accessible and provided with an adequate facility for cleansing, for example, traps are capable of being readily removed or dismantled. In general a trap which is not an integral part of an appliance should be attached to, and be immediately beneath, its outlet. However, traps that are not connected to the appliance should be as close as possible. There should be no more than one trap on the discharge pipework from any appliance.



Code **ASA10**

## Trap Seals

- Traps with outlets for pipes up to and including DN50 should have a minimum water seal of 50mm on baths and showers, provided they are fitted with flush-grated wastes without plugs on spray-tap basins; 75mm trap seals should be used with all other appliances
- Traps with outlets for pipes over DN50 should have a minimum water seal of 50mm
- Traps used on appliances with flat bottoms (trailing waste discharge) and discharging to a gully with a grating may have a reduced water seal of not less than 38mm

M<sup>c</sup>Alpine manufactures 19mm water seal traps to meet market demand for replacement traps or for situations where space is limited. These traps should **not** be used in situations where a minimum 50mm water seal trap is required or where the waste pipe is connected to a soil stack.

- **The table opposite is an extract for BS EN 12056-2:2000 Gravity Drainage Systems Inside Buildings**

## Notes relating to table opposite

- (1) Steeper gradients permitted if pipe is less than maximum permitted length
- (2) If length is greater than 3m noisy discharge may result with an increased risk of blockage
- (3) Should be as short as possible to limit problems with deposition
- (4) Sharp throated bends should be avoided
- (5) For slab urinal for up to 7 persons. Longer slabs to have more than one outlet
- (6) Swept - entry branches serving WC's
- (7) Includes small potato-peeling machines
- (8) Tubular not bottle or resealing traps
- (9) Spray tap basin shall have flush-grated wastes without plugs

Appliance	Diameter (DN)	Min. Trap Seal Depth (mm)	Max. Length (L) of Pipe from Trap Outlet to Stack (m)	Pipe Gradient (%)	Max. Number of Bends (no)	Max. Drop (m)
Washbasin, Bidet (30mm diameter trap)	30	75	1.7	2.2 <sup>(1)</sup>	0	0
Washbasin, Bidet (30mm diameter trap)	30	75	1.1	4.4 <sup>(1)</sup>	0	0
Washbasin, Bidet (30mm diameter trap)	30	75	0.7	8.7 <sup>(1)</sup>	0	0
Washbasin, Bidet (30mm diameter trap)	40	75	3.0	1.8 to 4.4	2	0
Shower, Bath	40	50	No Limit <sup>(2)</sup>	1.8 to 9.0	No Limit	1.5
Bowl Urinal	40	75	3.0 <sup>(3)</sup>	1.8 to 9.0	No Limit <sup>(4)</sup>	1.5
Trough Urinal	50	75	3.0 <sup>(3)</sup>	1.8 to 9.0	No Limit <sup>(4)</sup>	1.5
Slab Urinal <sup>(5)</sup>	60	50	3.0 <sup>(3)</sup>	1.8 to 9.0	No Limit <sup>(4)</sup>	1.5
Kitchen Sink (40mm diameter trap)	40	75	No Limit <sup>(2)</sup>	1.8 to 9.0	No Limit	1.5
Household Dishwasher or Washing Machine	40	75	3.0	1.8 to 4.4	No Limit	1.5
WC with Outlet up to 80mm <sup>(6)</sup>	75	50	No Limit	1.8 Min.	No Limit <sup>(4)</sup>	1.5
WC with Outlet greater than 80mm <sup>(6)</sup>	100	50	No Limit	1.8 Min.	No Limit <sup>(4)</sup>	1.5
Food Waste Disposal <sup>(7)</sup>	40 Min.	75 <sup>(8)</sup>	3.0 <sup>(3)</sup>	13.5 Min.	No Limit <sup>(4)</sup>	1.5
Sanitary Towel Disposal Unit	40 Min.	75 <sup>(8)</sup>	3.0 <sup>(3)</sup>	5.4 Min.	No Limit <sup>(4)</sup>	1.5
Floor Drain	50	50	No Limit <sup>(3)</sup>	1.8 Min.	No Limit	1.5
Floor Drain	70	50	No Limit <sup>(3)</sup>	1.8 Min.	No Limit	1.5
Floor Drain	100	50	No Limit <sup>(3)</sup>	1.8 Min.	No Limit	1.5
4 Basins	50	75	4.0	1.8 to 4.4	0	0
Bowl Urinals <sup>(8)</sup>	50	75	No Limit <sup>(3)</sup>	1.8 to 9.0	No Limit <sup>(4)</sup>	1.5
Maximum of 8 WC's <sup>(6)</sup>	100	50	15.0	0.9 to 9.0	2	1.5
Up to 5 Spray Tap Basins <sup>(9)</sup>	30 Max.	50	4.5 <sup>(3)</sup>	1.8 to 4.4	No Limit <sup>(4)</sup>	0



# Technical Details

## Installation Information

Most individual products are supplied with detailed installation instructions. The following is general information.

### Trap Inlets

When connecting the trap inlet to the waste outlet, it is important to ensure that a proper 'seating' is obtained and it is therefore recommended that the waste outlet used be to British Standard or equivalent, otherwise difficulty may be experienced in obtaining a water tight joint. All traps are supplied complete with inlet washers.

### Trap Outlets and Multifit Fittings see Page 2

For use with plastic pipes to BS EN 1451-1:2000 and BS EN 1329-1:2000, copper pipe (metric or imperial) and lead pipe. Fit as follows:

- Chamfer inside of pipe, if required to remove any burr or to enable plastic pipe to be eased over internal sleeve
- Remove nut, plastic friction washer and rubber olive from trap or fitting
- Push nut, plastic friction washer and rubber olive over pipe
- Push pipe over internal sleeve and into trap or fitting
- Connect nut and hand tighten

If a plastic pipe is undersize, or out of shape, the end may require to be warmed to enable it to be pushed over the internal sleeve and into the trap or fitting.

### Universal Trap Outlets and Fittings

Fit as Multifit but internal sleeve not applicable

### Surefit Fittings see Page 59

To BS EN 1329-1:2000

For use with M<sup>C</sup>Alpine HDPE waste pipe only. Fit as follows:

- Chamfer inside of pipe, if required to remove burr
- Remove nut and rubber washer from fitting
- Push nut and rubber washer over pipe

- Push pipe into socket
- Connect nut and hand tighten

### Pushfit Fittings see Page 67

For use with M<sup>C</sup>Alpine overflow pipe. Fit as follows:

- Gently warm end of pipe - say 25mm
- Push Fitting inside or outside of pipe dependent on type of fitting

### Pipe Clipping

It is of the utmost importance that plastic pipe be properly supported as recommended below:

		Waste (m)	Overflow (m)
Horizontal:	Every	0.5	0.5
Vertical:	Every	1.2	1.2



## Product Information

### Traps and Waste Outlet Fittings see Sections 1 and 7

All traps, waste outlets and overflows for kitchen sinks, shower trays, wash basins, bidets and baths meet the dimensional, performance, materials and marking requirements of EN 274-1:2002.

### Condensate Products see Pages 16-17

M<sup>C</sup>Alpine traps and fittings for connecting condensate discharge from condensing boilers to sanitary pipework meet the requirements of BS 6798:2009 and Building Regulations Approved Document H.

### Bath Fillers see Page 20

M<sup>C</sup>Alpine bath fillers have the following flow rates:

0.5 bar pressure produces 33 litres per minute

1.0 bar pressure produces 44 litres per minute

2.0 bar pressure produces 57 litres per minute

### Shower and Floor Gullies see Section 2

Shower and floor gullies are manufactured to comply with EN 1253-2:2003.

### Surefit Waste System see Page 59

Surefit waste system is manufactured to comply with BS EN 1329-1:2000.

### MACFIT WC Connectors see Pages 74-75

MACFIT WC connectors are manufactured to comply with BS 5627:1984.

### Flexible WC Connectors see Pages 76-78

Flexible WC connectors are manufactured to comply with German Standard DIN 1389:2001-05 and have LGA Approval, certificate number 7311072.

### Rigid WC Connectors see Pages 79-81

Rigid WC connectors are manufactured to comply with BS 5627:1984 and German Standard DIN 1389-2.

### Air Admittance Valves (Ventapipe) see Section 6

Air admittance valves (Ventapipe) are manufactured to comply with BS EN 12380:2002 and have LGA Approval.

Code **WC-CON8F18**



Code **VP50P**

# Index (Code Number in Alphabetical and Numerical Order)

Code	Page	Code	Page	Code	Page	Code	Page	Code	Page
<b>Numerical</b>		ASA10-SP	11/16	BOSSCONN110T-GR		BSW15P	95	C10R	5/6
228532	13/15	ASA10V	10		17/63	BSW15PC	95	C10V	6
32A-CB	60	ASA10W	11	BOSSCONN110Z-BL		BSW1P	93	CA32MINI-CB	8
32G-CB	60	ASC10	10		63	BSW1PC	93	CA32SQUK-CB	8
35A-CB	60	ASC10-CO	12/16	BOSSCONN110Z-GR		BSW2	94	CA32UK-CB	8
35B-CB	60	ASC10-SP	11/16		63	BSW21P	98	CAA10	7
35G-CB	60	ASC10V	10	BOSSCONN82-BL		BSW21PC	98	CAP100	62
40K-CB	60	ASE10	10		63	BSW2P	93	CBW70-CB	95
42A-CB	60	ASE10V	10	BOSSCONN82-GR		BSW2PC	93	CBW70-CLK	95
42B-CB	60				63	BSW3P	98	CBW70-SW	95
42E-CB	60	<b>B</b>		BOSSCONN82T-BL		BSW3PC	98	CBWF70CB	95
42G-CB	60	BATHTRAP25-CPB			63	BSW45P	98	CD1000-B	45
			22	BOSSCONN82T-GR		BSW6CP2H	98	CD1000-O-B	46
		BATHTRAP50-CPB			63	BSW6P	98	CD1000-O-P	46
			22	BOSSCONN82Z-BL		BSW6PC	98	CD1000-P	45
<b>A</b>		BL30-3/4	69		63	BSW6PR	98	CD1000-SQ	45
A10	6	BN1	106	BOSSCONN82Z-GR		BSW9P	95	CD1200-B	45
A10A	6	BN2	106		63	BSW9P-F	102	CD1200-O-B	46
A10AR	5/6	BN3	106	BP1-CAP	106	BSW9PC	95	CD1200-O-P	46
A10AR-CP	5/7	BN5	106	BP2-CAP	106	BSWCLS	100	CD1200-P	45
A10AV	6	BOSS110CAST-BL		BP2H	106	BSWCLS-OFSS		CD1200-SQ	45
A10AV-SV	7		17/63	BP3	106		100	CD600-B	45
A10R	5/6	BOSS110TCAST-BL		BP3H	106	BSWPVD	100	CD600-O-B	46
A10V	6		17/63	BP3T	106	BT1	11	CD600-O-P	46
A32UK-CB	8	BOSS82CAST-BL		BP4	106	BT2	11	CD600-P	45
A32UK-CP	8		17/63	BP4H	106	BT3	11	CD600-SQ	45
AA10	6	BOSS82TCAST-BL		BP4T	106	BT4	11	CD700-B	45
AA10W	6		17/63	BP5	106	BW1	93	CD700-O-B	46
ABS32/35A-CB	61	BOSS90CAST-BL		BRASSTRAP-25-CP		BW1A	93	CD700-O-P	46
ABS32/35A-CB-L			17/63		22	BW5	95	CD700-P	45
	61	BOSS90TCAST-BL		BRASSTRAP-50-CP		BW60SPH-CB	92	CD700-SQ	45
ABS32/35G-CB			17/63		22	BWSTOFRS	100	CD800-B	45
	61	BOSSCONN-22MM		BSKTOP	101	BWSTOFSS	100	CD800-O-B	46
ABS42/43A-CB			17/63	BSW-BR-CP	100	BWSTSS	100	CD800-O-P	46
	61	BOSSCONN1.25BL		BSW1	94	BWSTSS-TOP	101	CD800-P	45
ABS42/43G-CB			17/63	BSW10	95	BWU60SPH-CB		CD800-SQ	45
	61	BOSSCONN1.25GR		BSW10P	95		92	CD900-B	45
ABSCON-32X1.25			17/63	BSW10P-F	102			CD900-O-B	46
	60	BOSSCONN110-BL		BSW10PC	95	<b>C</b>		CD900-O-P	46
ABSCON-35X1.25			17/63	BSW10PR	98	C10	6	CD900-P	45
	60	BOSSCONN110-GR		BSW11P	93	C10A	6	CD900-SQ	45
ABSCON-42X1.5			17/63	BSW11PC	93	C10AR	5/6	CH10	106
	60	BOSSCONN110T-BL		BSW12	94	C10AR-CP	5/7	CH4	106
ARB-1	82		17/63	BSW12C	94	C10AV	6	CH4-18	106
ARW10	30	BOSSCONN110T-GR		BSW12T	94	C10AV-SV	7	CH5	106
ASA10	10		17/63						

Code	Page	Code	Page	Code	Page	Code	Page	Code	Page
CLAMP1GR	17	DC4-BL	62	FMBSWSS85	100	HD2-3M	59/67	MS4-TANK	55
CLAMP1WH	17	DC90-BL	62	FPKIT-3	82	HD3-3M	59	MS4L	54/69
CONFLEX-200	16	DC90-GR	62	FSK10	19	HWILF	69	MT18E	54
CONFLEX-300	16	DWU60-CB	92	FSK10E	19			MT18L	54
CONFLEX-KIT1	16	<b>E</b>		FSW1P	99	<b>L</b>		MT20	54
CONTRAP1	23	E10	6	FSW1PC	99	L10	18	MT20L	54
CONTRAP2	23	EXTA-F	77	FSW1PP	99	L10V	18	MT4	54/69
CONVALVE	17	EXTB-F	77	FSW2P	99			MT4-ISO	54
CONVALVE-125	70			FSW2PC	99	<b>M</b>		MT4-TANK	55
CONVALVE-125P	70	<b>F</b>		FSW2PC-70	99	MA15	13	MT4L	54/69
		FBSWPVD	100	FSW2PP	99	MAC-1	75	MZ18E	54
CP1	106	FBW1P	97	FSW2PP-70	99	MAC-1-BTW	75	MZ20	54
CP1H	106	FBW1PC	97	FSW2PR	99	MAC-3	75	MZ20L	54
CP2	106	FBW2P	97	FSW2PR-70	99	MAC-3C	75	MZ4	54/69
CP2H	106	FBW2PC	97	FSW45P	99	MAC-4	75	MZ4-ISO	54
CPTSG	50	FBW2PW	97	FVW1P	94	MAC-4A	75	MZ4-TANK	55
CRW10	30	FBW2R-C	97	FVW1PC	94	MAC-7A	75	MZ4L	54/69
CSWU3P	102	FBW2R-W	97	FVW1PW	94	MAC-8	75		
CTW1	105	FD90-T6SS	43			MAC-8L	75	<b>N</b>	
CW1	93	FD90-T6WH	43	<b>G</b>		MAC-EXTA	75	NUT-BLANK-WH	
CW5	95	FGT150-SV-110	42	G10	6	MAC-EXTB	75		58
CW60-CB	92		42	GWAL-CB	92	MAC-EXTC	75	NUT-WMVALVE	
CW60SP-CB	92	FGT150-SV-110S	42	GWU20	105	MACLINK	75		58
CW60SQ-CB	92		42			MACVALVE-1	9		
CWP60-SS	93	FGT150TOP	42	<b>H</b>		MACVALVE-2	9	<b>O</b>	
CWP60-SSP	93	FGTOP6SS	42/50	H11M	68	MACVALVE-3	9	O/FSTOP-BL	106
CWS5	102	FGTR118TOP	50	H28	68	MACVALVE-4	9	OBT1	11
CWS70-CB	95	FGTR118TOP-50	50	HANDIPAK CARDS	107	MBS85PVD	100	OBT1-CO	16
CWU1A	105		50			MBSWSS85	100	OBT1V	11
CWU1S	105	FGTR125TOP	42	HC2650-EXT-KIT	30	MD100	43		
CWU60-CB	92	FJ10	19		18	MD100-3	43	<b>P</b>	
CWU60SP-CB	92	FJ10WC	19	HC2650UK	20	MD200	43	P-OR-SHOWERTRP	
CWU60SQ-CB	92	FJWF1	21	HC2650UK-FIL	20	MD400	43		30
		FLEX-JKS	57	HC2650UK-FIL-1M	20	MDTOP-WH	42	P-RW-STW90	30
<b>D</b>		FLEXCON1	56		20	MDTOP20-WH	42	P10	18
DC1-BL	62	FLEXCON2	56	HCN3165UK	20	MESH-1	51	PIPE32-1000-CB	
DC1-BL-BO	62	FLEXCON2-LN	56	HCN3165UK-1M	20	MS18E	54		60
DC1-GR	62	FLEXCON3	56		20	MS18L	54	PIPE35-1000-CB	
DC1-GR-BO	62	FLEXCON4	56	HCN3365UK	20	MS20	54		60
DC1BL-OS	62	FLEXCON5	56	HCN3365UK-1M	20	MS20L	54	PIPE42-1000-CB	
DC1GR-OS	62	FLEXCON6	56		20	MS4	54/69		60
DC2-BL	62	FLEXCON7	56	HCUP50UK	23	MS4-32MM	54/61	PUB-CP	96
DC2BL-OS	62	FLEXCON8	56	HCUS50UK	23	MS4-32SOLVENT	54/61	PUB-CPB	96
DC3-BL	62	FLEXCON9	57	HD1-3M	59/67			PUB-CPX	96
DC3BL-OS	62	FLEXKIT1	14			MS4-ISO	54	PUB-PB-1M	96



# Index (Code Number in Alphabetical and Numerical Order)

Code	Page	Code	Page	Code	Page	Code	Page	Code	Page
PUB-PB-575	96	R33	68	S22L	58	SK2A	15	ST90CPB-S-HP2	
PUB-PB-700	96	R3M	66	S23	58	SK3	15		25
PUB-WH	96	R4	66	S23L	59	SM10	18	ST90CPB-S-V	25
PUBX-SP	96	R40	68	S23M	55	SM10E	18	ST90MECPTOP+S	
PUFS113-CP	101	R40E	68	S23MR	62	SM10EV	18	UPP	30
PUFS70-CP	101	R45	68	S23U	55	SM10V	18	ST90WH10-70	25
PUS113-CP	101	R45E	68	S25	58	SMP10	18	ST90WH10-HP	25
PUS70-CP	101	R4M	66/68	S26L	59	SMP10V	18	ST90WH10-HP2	
PUWF3-CP	21	R5	66	S28L	59	SOAK1GR	17		25
PWM1	30	R5M	66	S28L-ISO	54	SOAP-CP	106	ST90WH10-V	25
PWM2	30	R6	66	S28M	54	SP10	11	STW1-M	28
PWM3	30	R6A	66	S28M-NRV	57	SP10V	11	STW1-R	26
		R7	66	S29	55	SR10	11	STW10-R	26
		R8A	66	S29-LN	55	SS10	11	STW19-TUBE	30
<b>Q</b>		RS1	64	S30	59/67	SSINLET1	9/14	STW2-95	26
Q10	18	RS2	64	S31M	55	SSINLET2	9/14	STW2-M	28
		RS3	64	S31U	9	SSK1	14	STW2-R	26
<b>R</b>		RS4	64	S32-CP	60	SSK2	14	STW2M-95	28
R-3M	66	RS7	64	S35-CP	60	SSK3	14	STW3-M	28
R/SEAL-35X32	60	RW1	30	S4A	67	ST28L-ISO	54	STW3-R	26
R/SEAL-42X32	60	RW2	30	S4E	67	ST28M	54	STW3-RB	27
R/SEAL-42X35	60	RW3	30	S4L	59	ST70SS85	29	STW4-65	26
R1	66	RWILF	69	S4U	9	ST90-70B	47	STW4-95	26
R11	22	RWM1	30	S5	67/69	ST90-HP2B	47	STW4-M	28
R12	22	RWM2	30	S5M	55	ST90-HPB	47	STW4-R	26
R13	22/66	RWM3	30	S5M-A	55	ST90-OUT	55	STW4-RB	5/27
R14	22			S7	67	ST90CB10-53	24	STW4B-95	27
R15	22	<b>S</b>		S8A	58/67	ST90CB10-70	24	STW4M-95	28
R16	55/66	S1	58	S8B	58	ST90CB10-HP	24	STW5-M	28
R16-BL	17/63	S11M	55/68	S8M	55	ST90CB10-HP2	24	STW5-R	26
R16-GR	17/63	S12A-1	58	S9	67	ST90CB10-V	24	STW50-TUBE	30
R17	55/66	S12A-2	58	SA10	10	ST90CP10-53	24	STW6-95	26
R1M	66	S12A-3	58	SA10V	10	ST90CP10-70	24	STW6-M	28
R1M-CO	17/66	S12A-F	58	SB10	11	ST90CP10-HP	24	STW6-R	26
R2	66	S12C	58	SC10	10	ST90CP10-HP2	24	STW6M-95	28
R23U	66	S12D	58	SC10V	10	ST90CP10-V	24	STW7-M	28
R28-NRV	70	S13-ISON	58	SD10	11	ST90CPB-P-53	24	STW7-R	27
R29-NRV	70	S16	58	SE10	10	ST90CPB-P-70	24	STW7-RB	27
R2A	66	S17	59	SE10V	10	ST90CPB-P-HP	24	STW70CP	29
R2AM	66	S18	67	SF10	11	ST90CPB-P-HP2		STW70CPB	29
R2M	66	S18-ABS	55	SG10	11		24	STW70CPL	29
R3	66	S18L	59	SH10	11	ST90CPB-P-V	24	STW70GP	29
R30	68	S18M	59	SK1	15	ST90CPB-S-53	25	STW70LN	29
R30E	68	S1M	6	SK1A	15	ST90CPB-S-70	25	STW70LNL	29
R31	68	S21A	55	SK2	15	ST90CPB-S-HP	25	STW70SSM	29
R32	68								

## SECTION 8

Code	Page	Code	Page	Code	Page	Code	Page	Code	Page
STW70WH	29	T12A-3	58	T4U	9	TSG2-R125SS	36	TUN-1	70
STW70WHL	29	T12A-F	58	T5	67/69	TSG2-T150SS	36	TUN-2	17/54/70
STW70WHM	29	T12B	58	T5M	55	TSG2SS	34	TUN-3	70
STW8-95	27	T12C	58	T5M-A	55	TSG2SS-SL-NSC	34	TUN-4	70
STW8-M	28	T12D	58	T7	67	TSG2SS-SL-SC	34	TUN-6	70
STW8-R	27	T12E	58	T8A	58/67	TSG2T6SS	36	TUN5-CL	70
STW8-RB	27	T12F	58	T8B	58	TSG2T6WH	36	TUNKIT-1	71
STW80-TUBE	30	T12H	58	T8M	55	TSG2WH	34	TUNKIT-3	71
STW85CP	29	T12L	59	T9	67	TSG2WH-NSC	34	TUNVALVE	70
STW85CPB	29	T12M	54	TA32VUK-CB	8	TSG3-WH	35	TV1	13
STW85CPL	29	T12R	55	TAPSTOP-SS	106	TSG3SS	35	TWILF	69
STW85GP	29	T12S	59	TAPSTOP-SS40	106	TSG3SS-SL-NSC	35	TWL-18	67
STW85LN	29	T13-ISON	58	TAPSTOP-WH	106	TSG3SS-SL-SC	35	TWLFBR	68
STW85LNL	29	T16	58	TILE-PLAIN-B	47	TSG50-ANTI/LIG	40	TWLFVCV	69
STW85SSM	29	T17	59	TILE-PLAIN-P	47	TSG50-R125SS	36	TWS-18	67
STW85WH	29	T18	67	TP10	11	TSG50-T150SS	36	<b>U</b>	
STW85WHL	29	T18-ABS	55	TP10V	11	TSG50SS	34	UPSW-1	104
STW85WHM	29	T18L	59	TR10	11	TSG50SS-SL-NSC	34	UPSW-2	104
STW8B-95	27	T18M	59	TRSH10	11	TSG50SS-SL-SC	34	UPSW-2-22MM	104
STW8M-95	28	T1M	6	TS10	11	TSG50SS-SL-SC	34	UPSW-3	104
STWGR-CP	29	T21A	55	TSG1-ANTI/LIG	40	TSG50T6SS	36	UPSW-3-22MM	104
STWGR-WH	29	T22L	58	TSG1-R125SS	36	TSG50T6WH	36	UPSW-3-22MM	104
SW45P	98	T23	58	TSG1-T150SS	36	TSG50WH	34	UPSW-4-22MM	104
SWHF1-WH	102	T23L	59	TSG1-WH	34	TSG50WH-NSC	34	USG1-T150SS	37
SWHF2-WH	102	T23M	55	TSG1SS	34	TSG52-ANTI/LIG	40	USG1SS	35
SWHF3-CP	103	T23MR	62	TSG1SS-SL-NSC	34	TSG52-R125SS	36	USG1SS-SL-SC	35
SWHF3-WH	103	T23U	55	TSG1SS-SL-SC	34	TSG52-T150SS	36	USG1T6SS	37
SWHF4-CP	103	T25	58	TSG1T6SS	36	TSG52SS	34	USG1WH	35
SWHF4-WH	103	T26L	59	TSG1T6SS+STW1-	41	TSG52SS-SL-NSC	34	USG2-T150SS	37
SWHF5-CP	103	T28L	59	R	41	TSG52SS-SL-SC	34	USG2SS	35
SWHF5-WH	103	T28L-ISO	54	TSG1T6SS-STW2R	41	TSG52SS-SL-SC	34	USG2SS-SL-SC	35
SWHF6-CP	103	T28M	54	TSG1T6SSSTW295	41	TSG52T6SS	36	USG2T6SS	37
SWHF6-WH	103	T28M-FIL	55	TSG1T6SSSTW295	41	TSG52T6WH	36	USG2WH	35
SWILF	69	T28M-NRV	57	TSG1T6SSSTW295	41	TSG52WH	34	USG3-T150SS	37
SWL-18	67	T29	55	TSG1T6SSSTW295	41	TSG52WH-NSC	34	USG3SS	35
SWLFBR	68	T29-LN	55	TSG1T6WH	36	TSGCONTV	50	USG3SS-SL-SC	35
SWLFVCV	69	T30	59/67	TSG1WH-NSC	34	TSGCONTVSS	50	USG3T6SS	37
SWS-18	67	T30-CLAMP	58	TSG1WH-STW1R	41	TSGCONV	50	USG3WH	35
		T30-SPACER	58	TSG1WH-STW2R	41	TSGCONVSS	50	USGLEG1	51
		T31M	55	TSG1WH-STW2R	41	TSGSTOP	51		
<b>T</b>		T31U	9	TSG1WHSTW295	41	TT10	11		
T1	58	T42-CP	60	TSG2-ANTI/LIG	40				
T11M	55/68	T4A	67						
T12	58	T4E	67						
T12A-1	58	T4L	59						
T12A-2	58								

# Index (Code Number in Alphabetical and Numerical Order)

Code	Page	Code	Page	Code	Page	Code	Page	Code	Page
<b>V</b>		W3	98	WC-EXTB	80	WP3T	106	ZS31M	63
V15M	54	W4	95	WC-EXTC	80	WP4	106	ZT26L	54
V1L	59	W5	95	WC-EXTD	80	WP4T	106	ZT31M	63
V1M	54	WALLFLANGE-CP32		WC-F18R	76	WS3	102	ZWILF	69
V1MX	54		60	WC-F18S	76	WS5	102	ZWLFBR	68
V1MX-CO	17	WALLFLANGE-CP35		WC-F21R	78	WU10	105		
V21L	59		60	WC-F21S	78	WU11	105		
V23L	59	WALLFLANGE-CP42		WC-F23P	77	WU1A	105		
V24L	59		60	WC-F23PV	77	WU1S	105		
V33L	13	WC-BP1	81	WC-F23R	76	WU20	105		
V33S	13	WC-CON-EXT	81	WC-F23RV	76				
V33S-22	71	WC-CON1	79	WC-F23S	76	<b>X</b>			
V33T	71	WC-CON16	79	WC-F23SV	76	X10	11		
V33T-FP	71	WC-CON1V	79	WC-F26P	77	X10A	11		
V33WM	12	WC-CON2	79	WC-F26PV	77	X10V	11		
V34L	13	WC-CON2B	79	WC-F26R	76				
V8L	59	WC-CON3	79	WC-F26RV	76	<b>Y</b>			
V8M	54	WC-CON4	79	WC-F26S	76	Y10	11		
VP1	87	WC-CON4A	79	WC-F26SV	76				
VP100	86	WC-CON4B	79	WC17-90	82	<b>Z</b>			
VP100E	88	WC-CON5	79	WC17-110	82	Z1	58		
VP100N	86	WC-CON5B	79	WC17-114	82	Z11M	55/68		
VP15M	87	WC-CON6	79	WCTRAP4P	23	Z18L	59		
VP1W	87	WC-CON7	79	WCTRAP4S	23	Z18M	59		
VP2	87	WC-CON7A	79	WF21	21	Z21A	55		
VP2W	87	WC-CON7B	79	WF21-SP	22	Z23	58		
VP3	87	WC-CON8	80	WHB-1	10	Z23L	59		
VP4	87	WC-CON8E	80	WM1	12	Z23M	55		
VP50	86	WC-CON8F	77	WM11	12	Z23MR	62		
VP50-100	86	WC-CON8F-BTW		WM12	12	Z23U	55		
VP50P	86		78	WM14	12	Z28L	59		
VPSF-40/50	86	WC-CON8F-S-BTW		WM15	12	Z28L-ISO	54		
VSG1T6SS	39		78	WM2	12	Z28M	54		
VSG1WH	39	WC-CON8F18	77	WM2V	12	Z28M-NRV	57		
VSG1WH-NSC	39	WC-CON8F18-BTW		WM3	12	Z28M-NRVS	57		
VSG52T6SS	40		78	WM3-CAP	12	Z29	55		
VSG52WH	39	WC-CON8F18-S-		WM4	13	Z30	59		
		BTW	78	WMF3	13	Z31M	63		
<b>W</b>		WC-CON8FV	77	WMF4	13	Z4L	59		
W1	94	WC-CON8V	80	WP1	106	Z5M	55		
W10	67	WC-CON9	80	WP1T	106	Z8A	58		
W11	67	WC-CON9V	80	WP2	106	Z8B	58		
W1A	94	WC-CONQ	80	WP2H	106	Z8M	55		
W20	67	WC-CONQP	80	WP2T	106	ZP10	11		
W21	67	WC-EXTA	80	WP3	106	ZS26L	54		

